



PRODUCT CATALOGUE

Shelly

SMART AUTOMATION SYSTEMS

TABLE OF CONTENTS

INTRODUCTION	3	SHELLY BLU H&T.....	84-85
SHELLY SMART CONTROL APP.....	4-5	SHELLY BLU BUTTON TOUGH 1	86-87
SHELLY GEN3 series.....	6-7	SHELLY BLU BUTTON 1	88-89
SHELLY 1 Gen3.....	8-9	SHELLY BLU WALL SWITCH 4	90-91
SHELLY 1PM Gen3	10-11	SHELLY BLU DOOR/WINDOW	92-93
SHELLY i4 Gen3	12-13	SHELLY BLU MOTION.....	94-95
SHELLY 1 Mini Gen3.....	14-15	SHELLY BLU GATEWAY	96-97
SHELLY 1PM Mini Gen3.....	16-17	SHELLY QUBINO series.....	98-99
SHELLY PM Mini Gen3.....	18-19	SHELLY QUBINO WAVE 1 MINI.....	100-101
SHELLY DIMMER 0/1-10 V Gen3.....	20-21	SHELLY QUBINO WAVE 1PM MINI.....	102-103
SHELLY H&T Gen3.....	22-23	SHELLY QUBINO WAVE PM MINI.....	104-105
SHELLY PLUS series	24-25	SHELLY QUBINO WAVE 1	106-107
SHELLY PLUS 1	26-27	SHELLY QUBINO WAVE 1PM	108-109
SHELLY PLUS 1PM.....	28-29	SHELLY QUBINO WAVE 2PM	110-111
SHELLY PLUS 2PM.....	30-31	SHELLY QUBINO WAVE SHUTTER.....	112-113
SHELLY PLUS i4	32-33	SHELLY QUBINO WAVE i4.....	114-115
SHELLY PLUS RGBW PM	34-35	SHELLY QUBINO WAVE i4DC.....	116-117
SHELLY PLUS 0-10 V Dimmer.....	36-37	SHELLY QUBINO WAVE PLUG UK	118-119
SHELLY PLUS UNI.....	38-39	SHELLY QUBINO WAVE PLUG US.....	120-121
SHELLY PLUS SMOKE	40-41	SHELLY QUBINO WAVE PRO 1	122-123
SHELLY PLUS WALL DIMMER.....	42-43	SHELLY QUBINO WAVE PRO 2.....	124-125
SHELLY PLUS PLUG S	44-45	SHELLY QUBINO WAVE PRO 1PM.....	126-127
SHELLY PLUS PLUG UK	46-47	SHELLY QUBINO WAVE PRO 2PM.....	128-129
SHELLY PLUS PLUG IT	48-49	SHELLY DIMMER2.....	130-131
SHELLY PLUS PLUG US	50-51	SHELLY RGBW2	132-133
SHELLY WALL DISPLAY AND BLU H&T.....	52-53	SHELLY EM	134-135
SHELLY PRO series.....	54-55	SHELLY 3EM	136-137
SHELLY PRO 1	56-57	SHELLY PLUG	138-139
SHELLY PRO 1PM.....	58-59	SHELLY BUTTON 1	140-141
SHELLY PRO 2.....	60-61	SHELLY MOTION 2	142-143
SHELLY PRO 2PM.....	62-63	SHELLY H&T	144-145
SHELLY PRO 4PM.....	64-65	SHELLY TRV	146-147
SHELLY PRO 3.....	66-67	SHELLY FLOOD	148-149
SHELLY PRO 3EM.....	68-99	SHELLY DOOR/WINDOW 2.....	150-151
SHELLY PRO 3EM-400.....	70-71	SHELLY GAS.....	152-153
SHELLY PRO EM-50.....	72-73	SHELLY DUO.....	154-155
SHELLY PRO 3EM SWITCH ADD-ON	74-75	SHELLY DUO RGBW.....	156-157
SHELLY PRO DUAL COVER/SHUTTER PM	76-77	SHELLY VINTAGE.....	158-159
SHELLY PRO DIMMER 1PM.....	78-79	ACCESSORIES.....	160
SHELLY PRO DIMMER 2PM	80-81	WALL SWITCH FOR SMART DEVICE.....	161
SHELLY LAN SWITCH.....	82-83		



MAKE YOUR HOME AND OFFICE SMART

Shelly is a line of home automation devices that allows customers to control their home directly through a mobile phone or with a preferred home assistant. Shelly's devices are retrofit, which makes them suitable for every electrical installation with no need of additional changes or improvements.

With Shelly you can:

- > Control the lights by adjusting brightness, colors, and set custom schedules.
- > Control the home appliances or office equipment from anywhere.
- > Save energy and money with precise power metering.
- > Set custom automation features.
- > Monitor temperature, humidity, and brightness.
- > Receive immediate notifications in case of any status changes.
- > Power consumption control

All Shelly devices are designed to offer maximum comfort of living, safety and easy installation.



SHELLY SMART CONTROL APP



CONTROL YOUR HOME AND OFFICE WHEREVER YOU ARE! NO HUB REQUIRED!

All Shelly devices have:

- Embedded Web server
- Wi-Fi control and connectivity
- APIs for observation and control

YOUR SHELLY ACCOUNT

Shelly App user account is required to access, include, and control Shelly devices through the application. Once Shelly account is registered,

- Connect to existing W-Fi network or use Access Point mode locally to control Shelly devices
- Include, manage, and operate as many Shelly devices needed
- Configure devices and manage individual settings to every device individually
- Set custom scheduling for automatic actions by Shelly devices
- Create personalized rooms for more convenient control of the devices
- Define custom Groups to control multiple devices with one command in the app
- Build simple and complex scenes by combining Shelly devices to trigger certain actions in your home automation
- Monitor current and past electrical power consumption of the electrical circuit(s) and loads (for Shelly devices equipped with Power measuring capabilities)
- Build complex automation solutions for improved energy and operational efficiency
- Real time alerts and notifications based on your preference

FREE MOBILE APP



SHELLY CLOUD SERVICES

Shelly App offers possibility to control all Shelly devices remotely from any internet connection by using the Shelly Cloud Services – our own free cloud service with data storage.

HIGHLY COMPATIBLE!

Shelly devices are compatible with the most widely accepted both local and cloud based home automation platforms. Having a Shelly user account is necessary to include your Shelly devices to home automation platform.

All Shelly devices come with a REST API documentation, which is available at <http://shelly-api-docs.shelly.cloud/>

MQTT is supported by our firmware, which provides additional flexibility in the integration of Shelly to your home automation solution. And more integrations are added frequently.



amazon alexa



Google HOME



Yandex Alice

MQTT
enabled



SmartThings



Home
Assistant

{ REST }



Home Connect
Plus



Homey



HomeSeer



openHAB
empowering the smart home

iBroker
Automate your life

SYMCAN



Hubitat
ELEVATE YOUR ENVIRONMENT



HOOBS
HOME BRIDGE OUT OF THE BOX



Domoticz
control at your fingertips.



nynea

Shelly **Gen3**

Powered by Shelly Chip

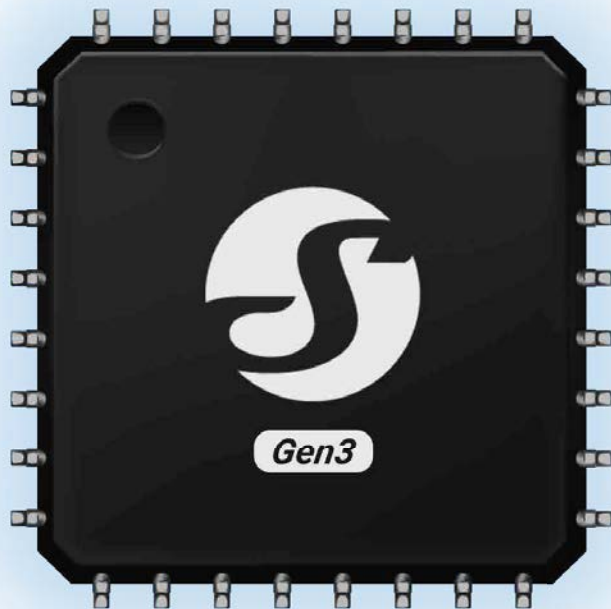

More Memory, More Power

8 MB
Memory

Matter
Upgradable

Virtual
Components

ON THE ROAD TO MATTER

Each Gen3 device is engineered to be upgradable to Matter. The doubled memory, compared to Plus series, guarantees a smooth update process, paving the way for new smart capabilities and integrations.

*dependent on the extent of Matter's functionalities support

MORE MEMORY, MORE POWER

The Gen3 series ensures the quality and reliability of our devices by using our own powerful Shelly chip. Boasting 8 MB of memory, this dramatically improves device performance and efficiency. This significant increase in memory not only guarantees smoother and faster operation but also equips the Gen3 series for the introduction of new capabilities.

UNIFIED CONTROL WITH VIRTUAL COMPONENTS

Gen3 Series introduces "virtual components", transforming how you manage and control 3rd party devices. Within the Shelly Smart Control app, you can now create virtual devices, integrating non-Shelly products into a unified control system. This feature provides streamlined control of all your smart devices, regardless of brand, from a single interface.



Shelly Gen3 1



SMART IRRIGATION

Using Shelly 1 Gen3, you can effortlessly set up your irrigation system to water your garden on sunny days and skip watering on rainy days. Using its advanced scripting capabilities or the Shelly Smart Control App Premium, you can configure the device to take weather forecasts into account, ensuring optimal watering schedules based on real-time weather conditions. For optimal precision in your automation, you can also use the Shelly Plus Add-on with a soil moisture sensor.

CONTROL YOUR GARAGE DOOR REMOTELY

Automate your garage door and gain control from anywhere in the world! Shelly 1 Gen3, with its operational voltages of 12V DC and 24-48V DC, is ideally suited for managing garage doors. By using the Shelly Plus Add-on and a Reed switch, you can also know the current state (open/closed).

OPTIMAL HEATING AND COOLING

With Shelly 1 Gen3, you can effortlessly control valves and heating/cooling manifolds in your home, ensuring precise water flow management for optimal temperature regulation and energy efficiency. Using it together with Shelly BLU H&T for each area, you can create schedules and scenes to open valves for hot water distribution when temperatures drop and switch between heating and cooling modes based on the current temperature. This setup maintains a comfortable climate year-round, reduces manual intervention, and allows remote adjustments.



Wi-Fi operated

Connect Shelly 1 Gen3 to your Wi-Fi network. No HUB required!



Bluetooth

Quick inclusion via Bluetooth or use it as a Bluetooth gateway.



Dry contacts

Use it to control a wide range of devices and appliances.



Low and high voltage support

Use a wide range of output voltage levels. Supports low voltages.



Smart schedules

Set custom schedules based on your daily agenda, or follow the sunrise/sunset and control your lighting accordingly.



Smart scenes

Set custom scenes by combining Shelly 1 Gen3 with your other Shelly devices.



VERSATILE AUTOMATION FOR ANY PROJECT

Our bestseller - now even more powerful, equipped with our own Shelly chip. Perfect for automating lighting, managing garage doors, and modernizing old appliances, **Shelly 1 Gen3** is the ideal choice for creating a more efficient, connected home and office. Its versatility makes it suitable for a wide range of automation projects.

TECHNICAL SPECIFICATIONS

Power supply	<ul style="list-style-type: none"> • 110-240 VAC, 50/60 Hz • 24-48 VDC • 12 VDC
Max load	16 A (240 V~)
Complies with EU standards:	<ul style="list-style-type: none"> • RED 2014/53/EU • LVD 2014/35/EU • EMC 2014/30/EU • RoHS2 2011/65/EU
Working temperature	-20°C to 40°C / -5°F to 105°F
Max RF power	< 20 dBm
Wireless/Wi-Fi Protocol	802.11 b/g/n (2.4 GHz)
Frequency	2400 - 2483.5 MHz
Operational range (depending on local conditions)	<ul style="list-style-type: none"> • Up to 30 m / 100 ft indoors • Up to 50 m / 160 ft outdoors
Dimensions (HxWxL)	42x37x16 mm / 1.46x1.65x0.63 in
Electrical consumption	< 1.2 W
CPU	ESP-Shelly-C38F
Flash	8 MB
Wire cross section range	0.2 to 2.5 mm ² / 24 to 14 AWG

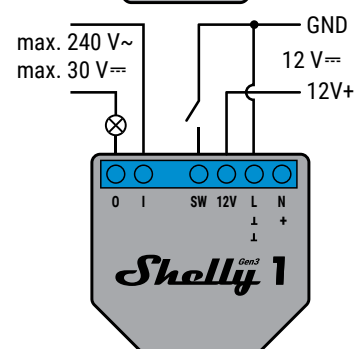
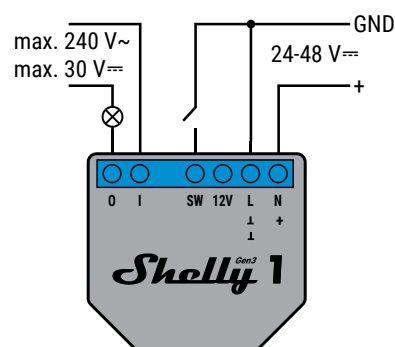
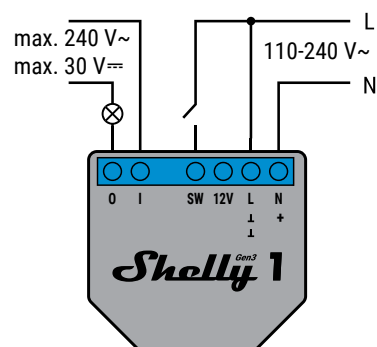

Legend

Device terminals:

- O:** Load circuit output terminal
- I:** Load circuit input terminal
- SW:** Switch input terminal (controlling O)
- +12V:** 12 V⁼⁼ positive terminal
- L:** Live terminal (110-240 V~)
- N:** Neutral terminal
- +:** 24-48 V⁼⁼ Positive terminal
- ⊥:** Negative terminal

Wires

- L:** Live wire (110-240 V~)
- N:** Neutral wire
- +:** 12/24-48 V⁼⁼ positive wire
- GND:** Ground wire 12/24-48 V⁼⁼

Shelly ^{Gen3} 1PM



MAKE YOUR WATER HEATER SMART

With Shelly 1PM Gen3, you can effortlessly automate and control your water heater, ensuring optimal energy usage and hot water exactly when you need it. By integrating Shelly 1PM Gen3 with your water heater, you can monitor energy consumption, set schedules, and remotely control it from your smartphone or smart home system. By using smart schedules, you can program your water heater to turn on during cheaper, off-peak hours, ensuring hot water is ready for morning showers while reducing energy costs. Additionally, you can connect it to Shelly Plus Add-on with a DS18B20 sensor and measure the temperature of the water inside.

EFFICIENT ELECTRICAL FLOOR HEATING

By installing Shelly 1PM Gen3, you can set your floor heating to start warming up the house before you wake up, providing a comfortable environment from the moment you step out of bed. You can also program it to lower the temperature during the night or when you're away, maintaining higher efficiency. This setup keeps your home's temperature comfortable while saving money by using energy efficiently, and allows you to make changes remotely.

EASY SMART SOCKET

With Shelly 1PM Gen3 installed behind a socket, you can automate and control various appliances, ensuring they operate according to your schedule and usage patterns. You can turn on your space heater remotely to warm up a room before you enter or turn off appliances during night hours. Using its power monitoring capabilities, you can track how much energy each appliance uses.



Power monitoring

Shelly Plus 1PM Gen3 provides precise monitoring of power consumption.



Wi-Fi Operated

Connect Shelly 1PM Gen3 to your Wi-Fi network. No HUB required!



Bluetooth

Add devices quickly and easily via Bluetooth connection, using Shelly Smart Control App.



Wide range of voltage support

Use it to control a wide range of devices and appliances.



Smart schedules

Set custom schedules based on your daily agenda or follow the sunrise/sunset and control your lighting accordingly.



Smart scenes

Set custom scenes by combining Shelly 1PM Gen3 with your other Shelly devices.



WI-FI-OPERATED SMART SWITCH WITH POWER METERING, 1 CHANNEL 16A

Shelly 1PM Gen3 is a Wi-Fi-operated smart switch for remote appliance control and precise power monitoring. Automate your home devices in less than 10 minutes, and control and monitor them from anywhere. Compact enough to fit behind most wall switches and sockets, it is retrofit and compatible with your existing smart home system.

TECHNICAL SPECIFICATIONS

Power supply	<ul style="list-style-type: none"> • 110-240 VAC, 50/60 Hz • 24-30 VDC
Max load	16 A
Complies with EU standards:	<ul style="list-style-type: none"> • RED 2014/53/EU • LVD 2014/35/EU • EMC 2014/30/EU • RoHS2 2011/65/EU
Working temperature	-20°C to 40°C / -5°F to 105°F
Max RF power	< 20 dBm
Wireless/Wi-Fi Protocol	802.11 b/g/n (2.4 GHz)
Frequency	2400 - 2483 MHz
Operational range (depending on local conditions)	<ul style="list-style-type: none"> • Up to 30 m / 100 ft indoors • Up to 50 m / 160 ft outdoors
Dimensions (HxWxL)	42x37x16 mm / 1.46x1.65x0.63 in
Electrical consumption	< 1.2 W
CPU	ESP-Shelly-C38F
Flash	8 MB
Wire cross section range	0.2 to 2.5 mm ² / 24 to 14 AWG

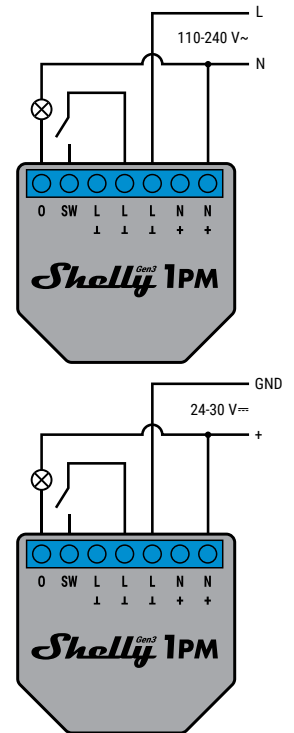

Legend

Device terminals

- O:** Load circuit output terminal
- SW:** Switch input terminal (controlling O)
- L:** Live terminal (110-240 V~)
- N:** Neutral terminal
- +:** 24-30 V⁺ positive terminal
- :** 24-30 V⁻ negative terminal

Wires

- L:** Live wire (110-240 V~)
- N:** Neutral wire
- +:** 24-30 V⁺ positive wire
- GND:** 24-30 V⁻ ground wire



Shelly Gen3 i4



CONTROL YOUR DEVICES EFFORTLESSLY

Shelly i4 Gen3 offers manual control of other Shelly devices. With it, you can easily turn off the lights, close the blinds, and even operate the garage door—all from one convenient spot. Enjoy the comfort of having full control of your home right at your fingertips with 16 different possible actions!

INSTANTLY ACTIVATE SCENES

Forgot to turn off the lights before bed? No need to worry! With Shelly i4 Gen3, you can activate a "Bedtime" scene with a single touch. Turn off all the lights, close the blinds, and activate the security system – all without leaving the comfort of your bed.

PERFECT MATCH

Shelly i4 Gen3 is an ideal companion for the Shelly Wall Switch for Smart Relays, featuring a 4-button design. Each button can trigger up to 4 different actions, allowing one switch to activate and execute up to 16 scenes.

With its compact size and simple wiring, the Shelly Wall Switch for Smart Relays easily fits into any existing switch console. No need to expand the wall space or modify the wiring!



Wi-Fi operated

Connect Shelly i4 Gen3 to your Wi-Fi network. No HUB required!



Bluetooth

Add devices quickly and easily via Bluetooth connection or use as a Bluetooth gateway.



Wide range of voltage support

Shelly i4 Gen3 can be powered by 110-240 V AC.



Multi-click support

Up to 16 possible actions. Activate any Shelly device and scenes you desire



Smart scenes

Set custom scenes by combining Shelly i4 Gen3 with your other Shelly devices.



Scripting

Shelly i4 Gen3 fully supports mJS scripting, allowing you to create custom features and functionalities.



FULL CONTROL AT YOUR SWITCH

Shelly i4 Gen3 is a smart device that lets you easily control various devices and scenes in your home. When placed behind a switch, you can instantly set the mood for movie night or turn off all the lights in your house from one convenient location. Now even more powerful, it's equipped with our own Shelly chip and quickly executes commands and sends notifications for various actions. You can use Shelly i4 Gen3 to control other Shelly relays, sensors, or devices controlled via HTTP and MQTT. Compact enough to fit behind any wall switch, Shelly i4 Gen3 can display status and control actions for up to four inputs.

TECHNICAL SPECIFICATIONS

Power Supply	• 110-240 VAC, 50/60 Hz
Multi-click support	Up to 16 possible actions (4 per button)
Complies with EU standards	<ul style="list-style-type: none"> • RED 2014/53/EU • LVD 2014/35/EU • EMC 2014/30/EU • RoHS2 2011/65/EU
Working temperature	-20°C to 40°C / -5°F to 105°F
Max RF power	<20 dBm
Radio protocol	Wi-Fi 802.11 b/g/n
Frequency	2400 - 2483 MHz
Operational range (depending on local conditions)	<ul style="list-style-type: none"> • Up to 30 m / 100 ft indoors • Up to 50 m / 160 ft outdoors
Dimensions	42x37x16 mm / 1.46x1.65x0.63 in
Power consumption	< 1 W
CPU	ESP-Shelly-C38F
Flash	8 MB
Wire cross section range	0.5 to 1.5 mm ² / 20 to 16 AWG

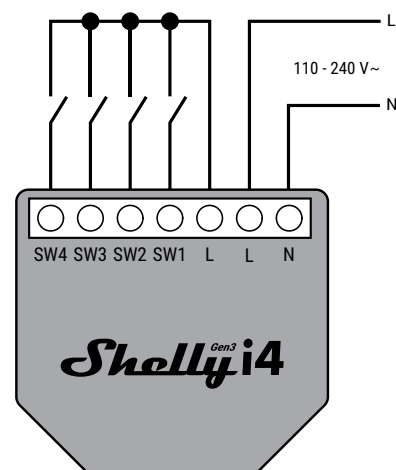

Legend

Device terminals

SW1, SW2, SW3, SW4: Switch input terminal

L: Live terminal (110-240 V~)

N: Neutral terminal

Wires

L: Live wire (110-240 V~)

N: Neutral wire



Shelly ^{Gen3} 1 MINI



LIGHTING CONTROL WHEREVER YOU NEED IT

Thanks to its compact size, Shelly Mini 1 Gen3 can discreetly fit within the ceiling rose of your lamp or in jammed wall boxes. Once installed, Shelly Mini 1 Gen3 enables you to effortlessly control your lights or other appliances using the Smart Control App, your preferred platform, or voice assistant. Easily customize your lights according to your daily routine with personalized schedules and save on energy. Set your hallway lights to automatically switch off past your family's bedtime, ensuring a peaceful night's sleep. And don't worry - you can still use your light switches manually to suit the needs of everyone in your home.



CONTROL YOUR GARAGE DOOR

Shelly 1 Mini Gen3's compact design allows for flexible placement options, enabling you to install it directly within the garage door opener's housing or even near the motor. Its 8A power handling capability ensures reliable garage door control, allowing you to conveniently operate your garage door remotely without the need for bulky external modules.



Wi-Fi operated

Connect Shelly 1 Mini Gen3 to your Wi-Fi network. No HUB required.



Bluetooth

Add devices quickly and easily via Bluetooth connection, using Shelly Smart Control App.



Dry contacts

Use a wide range of output voltage levels. Supports low voltages.



Extremely fast processor

For immediate command execution and notification.



Enhanced safety

Over-temperature protection for prevention of failures.



Enhanced security

MQTT and WSS support, TLS certificate support and management for a broad range of use cases.



Improved API interface

Broad range of cloud connections and local integrations.



No hub required

Control directly without a hub through your smartphone with Shelly Smart Control App.



Highly compatible

Use with your preferred home automation platforms and voice assistants.



Make any small electrical appliance smart

Shelly 1 Mini Gen3 is a small form factor smart switch with potential-free contacts, which allows remote control of electric appliances through a mobile phone, tablet, PC, or home automation system. It can work standalone in a local Wi-Fi network or it can also be operated through cloud home automation services. Shelly 1 Mini Gen3 can be accessed, controlled and monitored remotely from any place where the User has internet connectivity, as long as the device is connected to a Wi-Fi router and the Internet. It can be retrofitted into standard electrical wall boxes, behind power sockets and light switches or other places with limited space. Shelly 1 Mini Gen3 has embedded Web Interface which can be used to monitor and control the device, as well as adjust its settings.

TECHNICAL SPECIFICATIONS

Power Supply	• 110-240 VAC, 50/60 Hz
Complies with EU standards	• RED 2014/53/EU • LVD 2014/35/EU • EMC 2014/30/EU • RoHS2 2011/65/EU
Max switching voltage AC	240 V
Max switching voltage DC	30 V
Max switching current AC	8 A
Max switching current DC	5 A
Working temperature	-20°C to 40°C / -5°F to 105°F
Max RF power	<20 dBm
Wi-Fi protocol	802.11 b/g/n
Frequency	2400 - 2495 MHz
Operational range Wi-Fi (depending on local conditions)	• Up to 30 m / 100 ft indoors • Up to 50 m / 160 ft outdoors
Operational range Bluetooth (depending on local conditions)	• Up to 10 m / 33 ft indoors • Up to 30 m / 100 ft outdoors
Dimensions	29x34x16 mm / 1.11x1.34x0.63 in
CPU	ESP-Shelly-C38F
Flash	8 MB
Power consumption	< 1.2 W

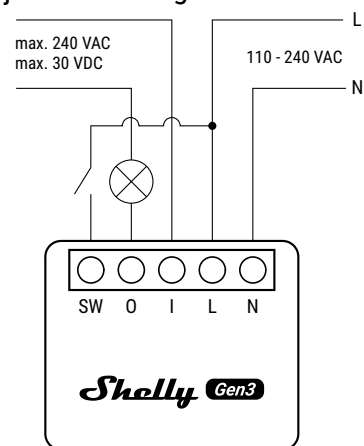

Legend

Device terminals:

SW: Switch input terminal

O: Relay output terminal

I: Relay input terminal

L: Live (110-240 VAC) terminal

N: Neutral terminal

Wires:

N: Neutral wire

L: Live (110 - 240 VAC) wire



Shelly Gen3 1PM MINI



TRACK YOUR POWER CONSUMPTION AND SAVE MONEY

Tailored for measuring the power consumption of appliances up to 8 A, Shelly 1PM Mini Gen3 is perfectly suited for monitoring smaller devices, including personal electronics, fans, lighting fixtures, and kitchen gadgets. By using it to monitor power consumption, you can manage energy usage and make informed adjustments to reduce electricity costs. Shelly 1PM Mini Gen3 offers free data storage, providing access to historical data for analysis and comparison, which can also help you identify devices consuming excessive power or working unnecessarily.



MAKE ANY SMALL ELECTRICAL APPLIANCE SMART

Transform old electrical appliances, like small heaters or kitchen gadgets into smart devices with Shelly 1PM Mini Gen3. It provides precise power monitoring, allowing you to track energy consumption in real-time, and gives you remote control over appliances, no matter where you are. You can wire it behind your socket or even inside the appliance's casing. Create custom schedules for your appliances based on your daily routine to save energy and set smart scenes to be prepared for any unexpected occurrences in your home!



Power metering with data storage

Provides precise monitoring of the power consumption.



Wi-Fi operated

Connect Shelly 1 PM Mini Gen3 to your Wi-Fi network.



Bluetooth

Add devices quickly and easily via Bluetooth connection, using Shelly Smart Control App.



Extremely fast processor

For immediate command execution and notification



Enhanced safety

Over-temperature protection for prevention of failures.



Enhanced security

MQTT and WSS support, TLS certificate support and management for a broad range of use cases.



Improved API interface

Broad range of cloud connections and local integrations.



No hub required

Control directly without a hub through your smartphone with Shelly Smart Control App



Highly compatible

Use with your preferred home automation platforms and voice assistants.

Smart control and precise power monitoring

Shelly 1PM Mini Gen3 is a small form factor smart switch with power measurement, which allows remote control of electric appliances through a mobile phone, tablet, PC, or home automation system. It can work standalone in a local Wi-Fi network or it can also be operated through cloud home automation services. Shelly 1PM Mini Gen3 can be accessed, controlled and monitored remotely from any place where the User has internet connectivity, as long as the device is connected to a Wi-Fi router and the Internet. It can be retrofitted into standard electrical wall boxes, behind power sockets and light switches or other places with limited space. Shelly 1PM Mini Gen3 has embedded Web Interface which can be used to monitor and control the device, as well as adjust its settings.

TECHNICAL SPECIFICATIONS

Power Supply	110-240 VAC, 50/60 Hz
Complies with EU standards	<ul style="list-style-type: none"> • RED 2014/53/EU • LVD 2014/35/EU • EMC 2014/30/EU • RoHS2 2011/65/EU
Max switching voltage AC	240 V
Max switching voltage DC	N/A
Max switching current AC	8 A
Max switching current DC	N/A
Working temperature	-20°C to 40°C / -5°F to 105°F
Max RF power	<20 dBm
Wi-Fi protocol	802.11 b/g/n
Frequency	2400 - 2495 MHz
Operational range Wi-Fi (depending on local conditions)	<ul style="list-style-type: none"> • Up to 30 m / 100 ft indoors • Up to 50 m / 160 ft outdoors
Operational range Bluetooth (depending on local conditions)	<ul style="list-style-type: none"> • Up to 10 m / 33 ft indoors • Up to 30 m / 100 ft outdoors
Dimensions	29x34x16 mm / 1.11x1.34x0.63 in
CPU	ESP-Shelly-C38F
Flash	8 MB
Power consumption	< 1.2 W

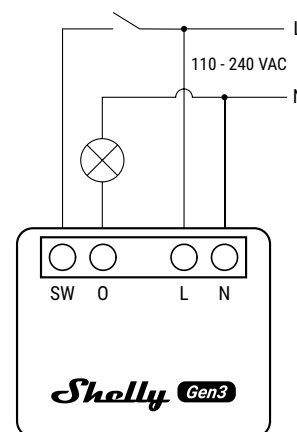

Legend

Device terminals:

- SW:** Switch input terminal
- O:** Relay output terminal
- L:** Live (110-240V) terminal
- N:** Neutral terminal

Wires:

- N:** Neutral wire
- L:** Live wire (110 - 240 VAC)



Shelly Gen3 PM MINI



PREVENTATIVE MONITORING

When an electrical appliance is damaged, it increases the amount of energy used in an attempt to compensate for its operational capacity. Shelly PM Mini Gen3 will fit anywhere you need it to and can immediately report the increase in energy consumption, saving you additional expenses on repairs or equipment replacement.

POWER CONSUMPTION ANALYSIS FOR COST OPTIMIZATION

Shelly PM Mini's gen3 smart energy metering will help you identify and eliminate any redundant energy consumption from each connected appliance around your home or facility. Together with smart scenes, you can use Shelly PM Mini's Gen3 data to set off scenarios, such as turning off appliances during a spike to protect them or during the night to save energy.



Power Meter

Provides precise monitoring of the power consumption



Wi-Fi operated

Connect Shelly Plus PM Mini to your Wi-Fi network.



Bluetooth

Add devices quickly and easily via Bluetooth connection, using Shelly Smart Control App.



Extremely fast processor

For immediate command execution and notification



Enhanced safety

Over-temperature protection for prevention of failures.



Enhanced security

MQTT and WSS support, TLS certificate support and management for a broad range of use cases.



Improved API interface

Broad range of cloud connections and local integrations.



No hub required

Control directly without a hub through your smartphone with Shelly Smart Control App



Highly compatible

Use with your preferred home automation platforms and voice assistants.

Track your power consumption and save money

Shelly Plus PM Mini is a small form factor power meter. It provides professional integrators with additional options for end-customer solutions. It can work standalone in a local Wi-Fi network, or it can also be operated through cloud home automation services through MQTT, HTTP, and WebSocket. All inbound connections support TLS. Shelly Plus PM Mini can be accessed, set up, and monitored remotely by the User, as well as the Device can access and communicate with an automation system, as long as they are in the same network infrastructure. The Device has an embedded Web Interface which can be used to monitor and control the device, as well as adjust its settings. **The Device does not have a built-in relay.**

TECHNICAL SPECIFICATIONS

Power Supply	• 110-240 VAC, 50/60 Hz
Complies with EU standards	<ul style="list-style-type: none"> • RED 2014/53/EU • LVD 2014/35/EU • EMC 2014/30/EU • RoHS2 2011/65/EU
Max measurement voltage	240 V
Max measurement current	16 A
Max measurement power	3840 W
Working temperature	-20°C to 40°C / -5°F to 105°F
Max RF power	<20 dBm
Wi-Fi protocol	802.11 b/g/n
Frequency	2400 - 2495 MHz
Operational range Wi-Fi (depending on local conditions)	<ul style="list-style-type: none"> • Up to 30 m / 100 ft indoors • Up to 50 m / 160 ft outdoors
Operational range Bluetooth (depending on local conditions)	<ul style="list-style-type: none"> • Up to 10 m / 33 ft indoors • Up to 30 m / 100 ft outdoors
Dimensions	29x34x16 mm / 1.11x1.34x0.63 in
CPU	ESP-Shelly-C38F
Flash	8 MB
Power consumption	< 1.2 W

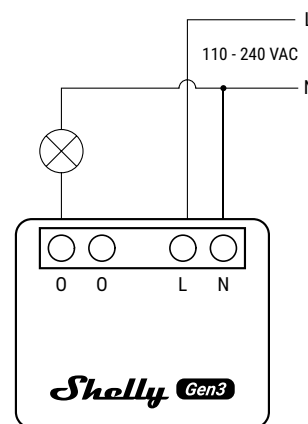

Legend

Device terminals:

O: Output terminals (bridged internally)

L: Live (110-240V) terminal

N: Neutral terminal

Wires:

N: Neutral wire

L: Live wire (110 - 240 VAC)





Dimmer 0/1-10V PM



BRIGHTNESS THAT SUITS YOUR ACTIVITIES

Depending on your activities and the time of day, different types of light and luminosity are suitable. With Shelly Dimmer 0/1-10V PM Gen3 you can align the minimum and maximum brightness levels with your driver's range for exact precision when adjusting your lights. Whether you want to set the ambiance for a relaxing evening or ensure the best brightness for focused tasks, it grants you fine-tuned control to match every moment. No need to navigate through the app - just use your voice!

PERSONALIZED LIGHT SCHEDULES

Shelly Dimmer 0/1-10V PM Gen3 can effortlessly blend with your daily routine. Consider bedtime: Many kids prefer to fall asleep with the lights turned on. You can set schedules that, over an hour, gently dim the room before switching the lights off completely. That way, the little one will be comfortably asleep, and no energy will go to waste!

SET THE MOOD INSTANTLY

Shelly Dimmer 0/1-10V PM Gen3 doesn't stop at schedules- it embraces moments too. With its pre-set lighting scenes, a simple voice command can transform your room. Feel like watching a movie? Just tell Alexa, "Movie night," and your space instantly adapts, casting the perfect ambiance for your cinematic experience.



Wi-Fi operated

Connect Shelly Dimmer 0/1-10V PM Gen3 to your Wi-Fi network. No HUB required!



Bluetooth inclusion

Quick inclusion via Bluetooth or use it as a Bluetooth gateway.



Power measurement

Provides precise monitoring of power consumption and free data storage.



Flexible input control

Use it with your existing switches, no matter if they're single or dual buttons.



Smart schedules

Set custom schedules based on your daily agenda, or follow the sunrise/sunset and control your lighting accordingly.



Smart scenes

Set custom scenes by combining Shelly Dimmer 0/1-10V PM Gen3 with your other Shelly devices.



SMART DIMMING CONTROLLER WITH POWER MEASUREMENT

Designed to manage 0/1-10V dimming drivers, **Shelly Dimmer 0/1-10V PM Gen3** offers precise dimming with power measurement. It is retrofit and can be used with any regular switch you have at home.

TECHNICAL SPECIFICATIONS

Power supply	110-240 V AC, 50/60 Hz
Max. switching voltage	240 V AC
Max. switching current	13 A
Max. control current	35 mA
Complies with EU standards:	<ul style="list-style-type: none"> • RED 2014/53/EU • LVD 2014/35/EU • EMC 2014/30/EU • RoHS2 2011/65/EU
Working temperature	-20°C to 40°C / -5°F to 105°F
Max RF power	< 20 dBm
Wireless/Wi-Fi Protocol	802.11 b/g/n (2.4 GHz)
Frequency	2400 - 2483.5 MHz
Operational range (depending on local conditions)	<ul style="list-style-type: none"> • Up to 30 m / 100 ft indoors • Up to 50 m / 160 ft outdoors
Dimensions (HxWxL)	38,5x43,5x17 mm / 1.52x1.71x0.67 in
Power consumption	< 1.5 W
CPU	ESP-Shelly-C38F
Flash	8 MB
Wire cross section range	0.2 to 2.5 mm ² / 24 to 14 AWG

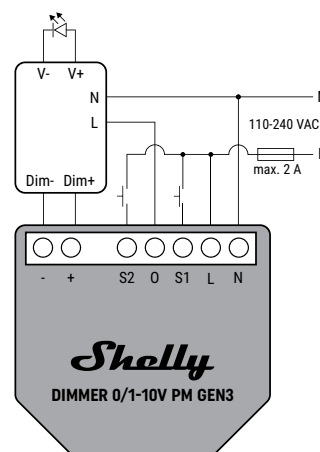

Legend

Device terminals

- +**: 0-10 VDC positive terminal
 - : 0-10 VDC negative terminal
 - O**: Relay output
 - S1**: Switch/button input terminals for light control
 - S2**: Switch/button input terminals for light control
 - L**: Live (110-240 V) terminal
 - N**: Neutral terminal
 - Dim+ / Dim-**: Positive/negative terminal of the LED driver
 - V+ / V-**: Positive/negative output of the LED driver
- #### Wires
- N**: Neutral wire
 - L**: Live (110-240 V) wire



Shelly^{Gen3} H&T



INTELLIGENT HUMIDITY CONTROL

Maintain a healthy environment in your bathroom with the Shelly H&T Gen3. By integrating the sensor with Shelly Plus 1 wired to your bathroom fan, you can automate humidity control with ease. Set a scene where, upon detecting high humidity levels, the Shelly Plus 1 activates the fan, effectively reducing moisture. This adds a touch of convenience to your daily routine, ensuring your bathroom remains comfortable and dry, automatically.



DUAL-POWERED

4 x Regular 1.5 V AA (LR) batteries

When used with batteries, Shelly H&T Gen3 has over one year of battery life thanks to its low energy-consuming display.

USB Power supply

Shelly H&T Gen3 is enhanced with a type-C USB slot. While it cannot be used to charge the device's batteries, it allows for continuous power, faster connection and more frequent reports.



Wi-Fi Operated

Connect Shelly H&T Gen3 to your Wi-Fi network. No HUB required



Bluetooth connectivity

Quick inclusion via Bluetooth or use it as a Bluetooth gateway



Measures humidity

Monitor changes in humidity levels to avoid dryness and mold growth



Measures temperature

Be aware of temperature fluctuations and maintain comfortable conditions



Free data history

Features up to 1 year of free data storage for analysis and statistics



Long battery life

Over 1 year of battery life and a USB type-C slot for continuous power

EXCEPTIONAL PERFORMANCE

Discover the power of enhanced memory with Shelly H&T Gen3. Equipped with our Shelly chip featuring 8 MB of memory, it doubles the efficiency and responsiveness. The leap in memory capacity prepares Gen3 devices for upcoming features, and provides smoother operation and quicker responses, ensuring your environment is monitored with unparalleled precision and ease.

TECHNICAL SPECIFICATIONS

Power Supply	<ul style="list-style-type: none">• Batteries: 4 AA (LR6) 1.5 V (batteries not included)• USB power supply: Type-C (cable not included)
Low battery consumption	Up to 1-year life of the batteries
Complies with EU standards	<ul style="list-style-type: none">• RED 2014/53/EU• LVD 2014/35/EU• EMC 2014/30/EU• RoHS2 2011/65/EU
CPU	ESP-Shelly-C38F
Ambient temperature	0 °C to 40 °C / 32 °F to 104 °F
Max RF power	20 dBm
Radio protocol	Wi-Fi 802.11 b/g/n
Frequency	2400 - 2483 MHz
Operational range Wi-Fi (depending on local conditions)	<ul style="list-style-type: none">• Up to 30 m / 100 ft indoors• Up to 50 m / 160 ft outdoors
Bluetooth protocol	4.2
Bluetooth operational range (depending on local conditions)	<ul style="list-style-type: none">• Up to 30 m / 100 ft outdoors• Up to 10 m / 33 ft indoors
Dimensions	<ul style="list-style-type: none">• without stand: 70x70x26 mm / 2.76x2.76x1.02 in• with stand: 70x70x45 mm / 2.76x2.76x1.77 in
CPU	ESP-Shelly-C38F
Flash	8 MB
Electrical consumption	<ul style="list-style-type: none">• Sleep mode $\leq 32\mu\text{A}$• Setup mode $\leq 76\text{mA}$

NOW IN MORE MATTE COLORS

Experience the perfect blend of functionality and fashion with Shelly H&T Gen3, now available in three new colors. Whether you prefer a subtle touch or a bold statement, the Shelly H&T Gen3 adapts to your style, ensuring your home's comfort and design are in perfect harmony. It's not just about functionality; it's about complementing your living space with a device that feels like it was made just for you.



EXCEPTIONAL FACILITY AUTOMATION AND CONTROL

Shelly smart switches now come with perfected electrical appliances control through an extremely fast processor, quicker connectivity, improved integration, and enhanced safety! You can now add devices easily via Bluetooth connection, using Shelly Smart Control App. Shelly Plus line supports TLS encryption and has an improved shell for standardized support for external sensor plugs.



Extremely fast processor



Bluetooth connectivity



Improved integration



Enhanced safety



Scripting

IMPROVED AND COMPACT SHELL

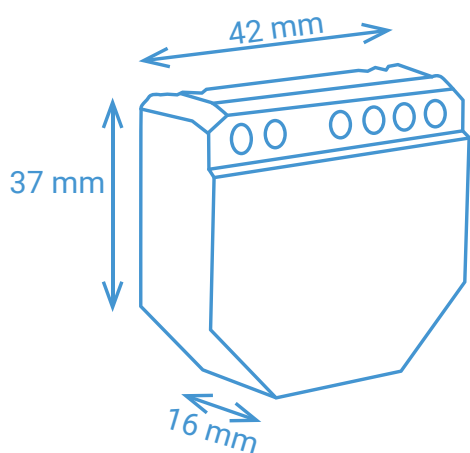

Shelly Plus line comes in a unified and improved form with small dimensions that allow easy fit behind any wall switch or wall socket, and are fully retrofit. Each Plus line device comes with a wiring diagram printed on its shell to ensure safe and easy installation.



HTTP/HTTPS webhooks

Get notifications or control another compatible equipment or 3rd party automation system.

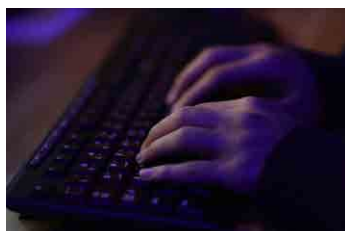

Scripting for custom automation

Get enhanced functionalities and additional processes settings for a specific integration or function.



Weekly scheduling automation

Quickly set actions based on your daily or weekly schedule.



Smart actions for dynamic control

Set Shelly Plus devices to switch on/off the power, based on the Sunset/Sunrise hour and enjoy dynamic control.

Shelly PLUS

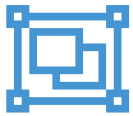

Improved API interface



Standardized RPC



Lower implementation cost

IMPROVED INTEGRATION

Shelly Plus line has an improved API interface and standardized RPC, allowing a broad range of cloud-connected and local integrations for a much lower cost for implementation. Scripting functionalities allow customization of home automation experience with a specific integration.

ENHANCED SAFETY & SECURITY

Shelly Plus line provides enhanced safety with additional temperature sensing software thresholds for control and prevention of failures. Devices' firmware now supports more encryption modes and secure storage.

An improve security is guaranteed by MQTT and WSS support, as well as custom certificates support for a broad range of use cases. Devices can be used with your one local or a centralized server, keeping them fully isolated from the public Internet.



Overtemperature protection



Failures prevention



MQTT and WSS support

SHELLY PLUS LINE



SHELLY PLUS 1

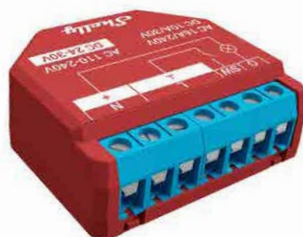

SHELLY PLUS 1PM



SHELLY PLUS 2PM



SHELLY PLUS i4

Shelly PLUS 1



LIGHTS THAT FOLLOW YOUR SCHEDULE

Automate your lights with Shelly Plus 1 and use Shelly App to set automated scenes based on hour or sunset/sunrise or based on the hour you come back from work.

GARAGE DOOR CONTROL

Easily automate your garage door and control it no matter where you are! Shelly Plus 1 has operational voltages of 12 VDC and 24-48 VDC.



IRRIGATION SYSTEM THAT FOLLOWS THE WEATHER

Use scripting functionalities and Shelly Plus 1 to automate your irrigation system. That way it will water your garden only when it is sunny, skipping the rainy days.



Wi-Fi operated

Connect Shelly Plus 1 to your Wi-Fi network. No HUB required.



Bluetooth

Add devices quickly and easily via Bluetooth connection, using Shelly Smart Control App.



Dry contacts

Use a wide range of output voltage levels. Supports low voltages.



Extremely fast processor

For immediate command execution and notification.



Enhanced safety

Over-temperature protection for prevention of failures.



Enhanced security

MQTT and WSS support, TLS certificate support and management for a broad range of use cases.



Improved API interface

Broad range of cloud connections and local integrations.



No hub required

Control directly without a hub through your smartphone with Shelly Smart Control App.



Highly compatible

Use with your preferred home automation platforms and voice assistants.

PERFECTED HOME AUTOMATION EXPERIENCE AND ENHANCED LIGHTING CONTROL!

Intended for mounting behind the wall switch console or power socket, **Shelly Plus 1** brings enhanced control and automatization of the lights, garage door, the irrigation system, bathroom fan, and pretty much every old electrical appliances. Thanks to its small dimensions, it can fit even in the tiniest spaces.

TECHNICAL SPECIFICATIONS

Power supply	<ul style="list-style-type: none"> • 110-240 VAC, 50/60 Hz • 24-48 VDC • 12 VDC
Max load	16 A / 15 A UL version
Complies with EU standards:	<ul style="list-style-type: none"> • RED 2014/53/EU • LVD 2014/35/EU • EMC 2014/30/EU • RoHS2 2011/65/EU
Working temperature	-20°C to 40°C / -5°F to 105°F
Max RF power	13.45 dBm
Wireless/Wi-Fi Protocol	802.11 b/g/n (2.4 GHz)
Frequency	2400 - 2483 MHz
Operational range (depending on local conditions)	<ul style="list-style-type: none"> • Up to 30 m / 100 ft indoors • Up to 50 m / 160 ft outdoors
Dimensions (HxWxL)	42x37x16 mm / 1.46x1.65x0.63 in
Electrical consumption	< 1.2 W
CPU	ESP-32
Flash	4 MB
Wire cross section range	0.5 to 1.5 mm ² / 20 to 16 AWG

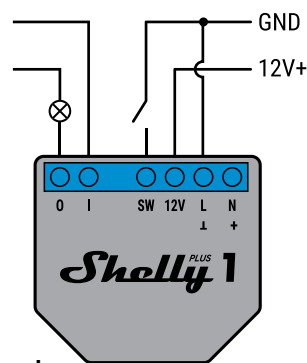
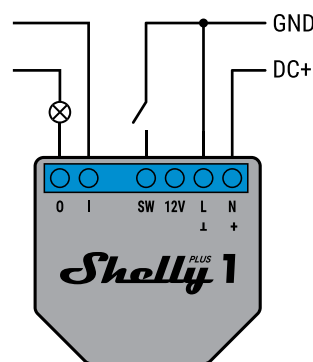
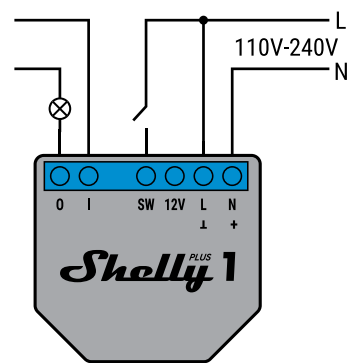

Legend

Terminals:

- N:** Neutral terminal
- L:** Live (110-240 V) terminal
- O:** Output terminal
- I:** Input terminal
- SW:** Switch terminal
- +**: DC positive terminal (24-48 V)
- ⊥:** DC ground terminal
- 12 V:** DC positive terminal (12 V stabilized)

Wires:

- N:** Neutral wire
- L:** Live (110-240 V) wire
- GND:** DC ground wire
- DC+:** DC positive (24-48 V) wire
- 12V+:** DC positive (12 V) wire

Shelly PLUS 1PM

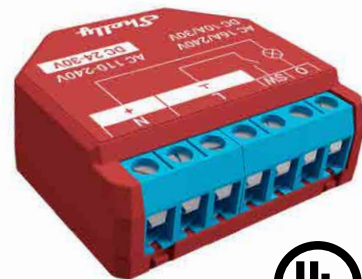

TRACK THE POWER CONSUMPTION

Shelly Plus 1PM has an integrated precise power meter that allow you to measure the power consumption and features free data storage for analysis.



HEATING CONTROL ON SCHEDULE

Set Shelly Plus 1PM to turn on the heating appliances in your house an hour before you come from work. Remotely monitor the power consumption of your heaters to make sure they're running and warming up.



APPLIANCES AUTOMATION

Get precise measurement of the power consumption of your home appliances and switch them on/off remotely, no matter where you are.



Power metering with data storage

Provides precise monitoring of the power consumption.



Wi-Fi operated

Connect Shelly Plus 1 PM to your Wi-Fi network.



Bluetooth

Add devices quickly and easily via Bluetooth connection, using Shelly Smart Control App.



Extremely fast processor

For immediate command execution and notification



Enhanced safety

Over-temperature protection for prevention of failures.



Enhanced security

MQTT and WSS support, TLS certificate support and management for a broad range of use cases.



Improved API interface

Broad range of cloud connections and local integrations.



No hub required

Control directly without a hub through your smartphone with Shelly Smart Control App



Highly compatible

Use with your preferred home automation platforms and voice assistants.

NEXT GENERATION APPLIANCES CONTROL WITH PRECISE POWER METERING

Small enough to fit behind any wall switch or wall socket, **Shelly Plus 1PM** is designed for retrofit applications and can be installed in less than 10 minutes. From automatization of the lights to electrical appliances control, Shelly Plus 1PM provides precise power metering and free cloud data storage.

TECHNICAL SPECIFICATIONS

Power supply	<ul style="list-style-type: none"> • 110-240 VAC, 50/60 Hz • 24-30 VDC
Max load	16 A / 15 A UL version
Complies with EU standards:	<ul style="list-style-type: none"> • RED 2014/53/EU • LVD 2014/35/EU • EMC 2014/30/EU • RoHS2 2011/65/EU
Working temperature	-20°C to 40°C / -5°F to 105°F
Max RF power	13.38 dBm
Wireless/Wi-Fi Protocol	802.11 b/g/n (2.4 GHz)
Frequency	2400 - 2483 MHz
Operational range (depending on local conditions)	<ul style="list-style-type: none"> • Up to 30 m / 100 ft indoors • Up to 50 m / 160 ft outdoors
Dimensions (HxWxL)	42x37x16 mm / 1.46x1.65x0.63 in
Electrical consumption	< 1.2 W
CPU	ESP-32
Flash	4 MB
Wire cross section range	0.5 to 1.5 mm ² / 20 to 16 AWG

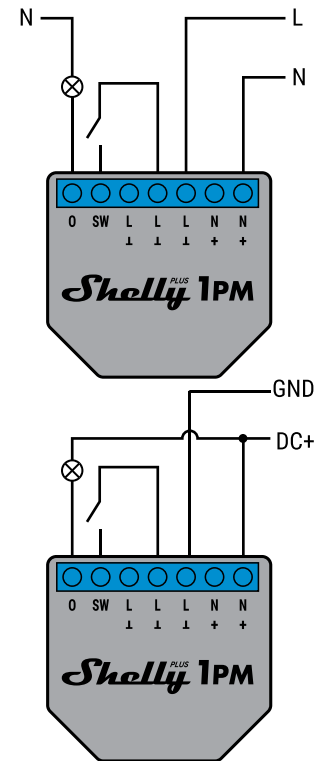

Legend

Terminals:

N: Neutral terminal
L: Live (110-240 V) terminal

O: Output terminal

SW: Switch terminal

+: DC positive terminal

-: DC ground terminal

Wires:

N: Neutral wire

L: Live (110-240 V) wire

GND: DC ground wire

DC+: DC positive (24-30 V) wire

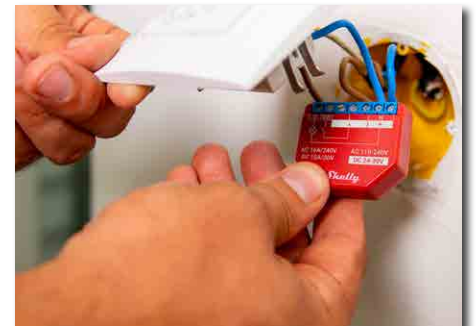

Shelly PLUS 2PM



CURTAINS THAT FOLLOW YOUR SCHEDULE

Use the “Schedules” function to create the perfect morning/evening routines by setting Shelly Plus 2PM to open/close the curtains in your home at pre-set hours every day.

AWNING THAT FOLLOWS THE FORECAST

Set Shelly Plus 2PM to close your garden awning in case of a strong wind to prevent it from breaking.



CONTROL 2 LIGHTS WITH ONE DEVICE

Shelly Plus 2PM allows you to control and monitor two different circuits, measuring their consumption separately.

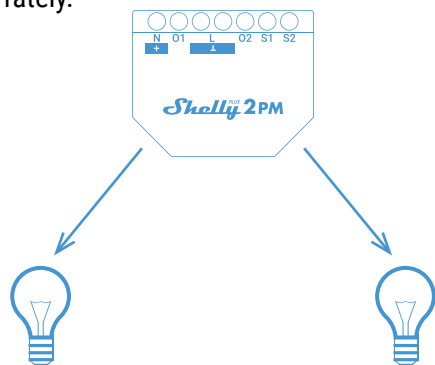

Wi-Fi operated

Connect Shelly Plus 2PM to your Wi-Fi network. No HUB required.



Bluetooth

Add devices quickly and easy via Bluetooth connection, using Shelly Smart Control App.



Power metering with data storage

Provides precise monitoring of the power consumption.



Cover (roller) and position control

Control two-directional AC motors and set your desired position.



Wide range of voltage support

Can be powered by 110-240V AC & 24V DC, and supports up to 10A per channel and 16A total.



Extremely fast processor

For immediate command execution and notification.



Enhanced safety

Over-temperature protection for prevention of failures.



Enhanced security

MQTT and WSS support, TLS and custom certificates support for a broad range of use cases.



Improved API interface

Broad range of cloud connections and local integrations.



No hub required

Control directly and without a hub through your smartphone with Shelly Smart Control App.



Highly compatible

Use with your preferred home automation platforms and voice assistants.

NEXT GENERATION 2-CHANNEL SWITCH WITH COVER AND POSITION CONTROL

Shelly Plus 2PM allows automation of roller shutters, blinds, curtains, awnings, gates, and any bi-directional AC motors. Two integrated precise power meters allow you to measure the consumption for each channel separately. Shelly Plus 2PM has scripting functionalities for customized features and even more intuitive automation.

TECHNICAL SPECIFICATIONS

Power supply	<ul style="list-style-type: none"> • 110-240 VAC, 50/60Hz • 24 VDC ±10%,
Max load per channel	10 A / 8 A UL version
Max. device load	16 A
Complies with EU standards:	<ul style="list-style-type: none"> • RED 2014/53/EU • LVD 2014/35/EU • EMC 2014/30/EU • RoHS2 2011/65/EU
Working temperature	-20°C to 40°C / -5°F to 105°F
Max RF power	< 20 dBm
Wireless/Wi-Fi Protocol	802.11 b/g/n (2.4 GHz)
Frequency	2400 - 2483 MHz
Operational range (depending on local conditions)	<ul style="list-style-type: none"> • Up to 30 m / 100 ft indoors • Up to 50 m / 160 ft outdoors
Dimensions (HxWxL)	42x37x16 mm / 1.46x1.65x0.63 in
Electrical consumption	< 1,4 W
Wire cross section range	0.5 to 1.5 mm ² / 20 to 16 AWG

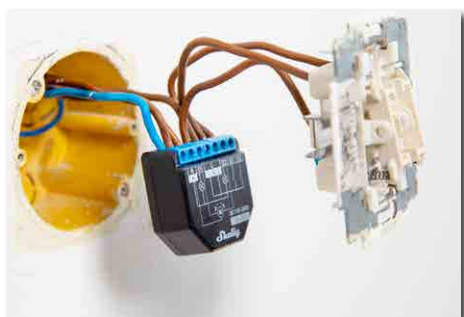

USE SHELLY PLUS 2PM TO AUTOMATE:

- ✓ Blinds
- ✓ Roller Shutters
- ✓ Curtains
- ✓ Awnings
- ✓ Garage Doors
- ✓ Lights

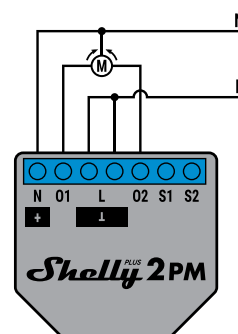
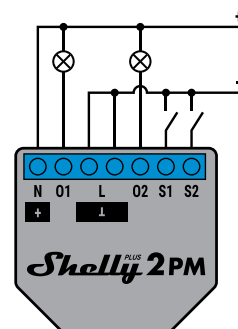
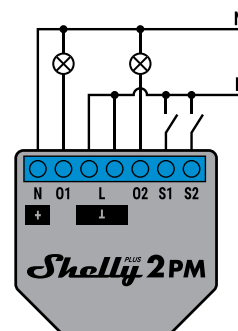

Legend

Device terminals:

- O1:** Load circuit 1 output terminal
- O2:** Load circuit 2 output terminal
- S1:** Switch (controlling O1) input terminal
- S2:** Switch (controlling O2) input terminal
- L:** Live (110-240 VAC) terminals
- N:** Neutral terminal
- +**: 24 VDC positive terminal
- :** 24 VDC negative terminal

Wires:

- N:** Neutral wire
- L:** Live (110-240 VAC) cable
- +**: 24 VDC positive wire
- :** 24 VDC negative wire

Shelly PLUS i4

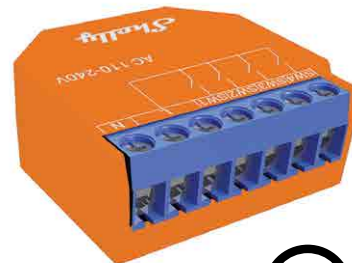

COMPLEX SCENE ACTIVATION

Manually activate or deactivate complex scenes. With Shelly Plus i4 you can run synchronized actions of several Shelly devices. You can install Shelly Plus i4 close to the front door of your home and turn off/on all the lights in your house with one push of the button, saving you time when you are in a hurry.



MANUAL CONTROL OF OTHER SHELLEY DEVICES



Wi-Fi operated

Connect Shelly Plus i4 directly to your Wi-Fi network.



Bluetooth

Add devices quickly and easy via Bluetooth connection, using Shelly Smart Control App



Wide range of voltage support

Shelly Plus i4 can be powered by 110-240 V AC



Multi-actions support

Up to 12 possible actions.



Extremely fast processor

For immediate command execution and notification



Enhanced security

MQTT and WSS support, TLS and custom certificates support for a broad range of use cases.



Improved API interface

Broad range of cloud connections and local integrations.



No hub required

Control directly and without a hub through your smartphone with Shelly Smart Control App.



Highly compatible

Use with your preferred home automation platforms and voice assistants

SMART SCENES ACTIVATION WITH ENHANCED CONTROL

Shelly Plus i4 allows customers to manually activate or deactivate any created scene, run synchronized actions, or execute complex trigger scenarios. Shelly Plus i4 can control other connected Shelly switches, sensors, or HTTP and MQTT-controlled devices. Thanks to its small dimensions, it can fit behind every wall switch.

TECHNICAL SPECIFICATIONS

Power Supply	• 110-240 VAC, 50/60 Hz
Multi-click support	Up to 12 possible actions (3 per button)
Complies with EU standards	<ul style="list-style-type: none"> • RED 2014/53/EU • LVD 2014/35/EU • EMC 2014/30/EU • RoHS2 2011/65/EU
Working temperature	-20°C to 40°C / -5°F to 105°F
Max RF power	14.9 dBm
Radio protocol	Wi-Fi 802.11 b/g/n
Frequency	2400 - 2483 MHz
Operational range (depending on local conditions)	<ul style="list-style-type: none"> • Up to 30 m / 100 ft indoors • Up to 50 m / 160 ft outdoors
Dimensions	42x37x16 mm / 1.46x1.65x0.63 in
Electrical consumption	< 1 mW
Wire cross section range	0.5 to 1.5 mm ² / 20 to 16 AWG



Smart Bulbs control like never before

Whether you use Shelly Wi-Fi bulbs or different brands smart bulbs, Shelly Plus i4 is highly compatible and can control them all! Furthermore, you can use Shelly Plus i4 to set the light color you want or for dimming of your smart bulbs. All you have to do is add and configure one of our scripts or webhooks created specifically for Shelly Plus i4

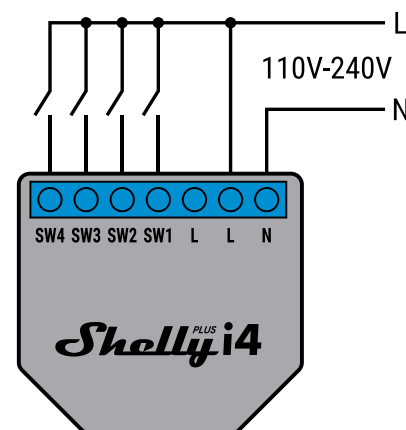

Legend

Terminals:

- N:** Neutral terminal
- L:** Live (110-240V) terminal
- SW1:** Switch terminal
- SW2:** Switch terminal
- SW3:** Switch terminal
- SW4:** Switch terminal

Wires:

- N:** Neutral wire
- L:** Live (110-240V) wire

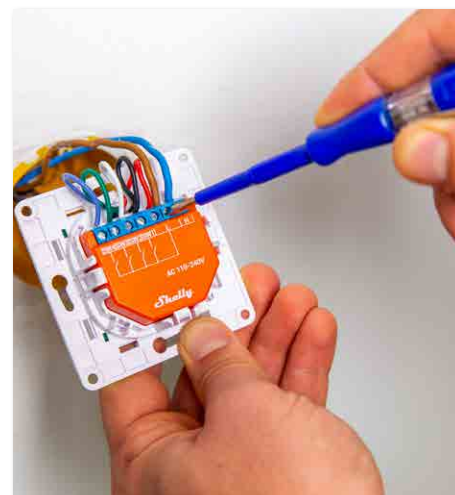

Shelly ^{PLUS} RGBW PM

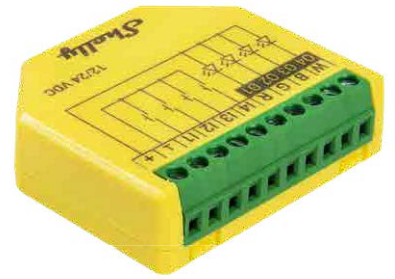

UNDER-CABINET LIGHTING

Under-cabinet lighting makes a huge difference when you're the chef in the kitchen. With the ability to shift through an array of colors and adjust the level of brightness, you can quickly tailor the room's ambience to your cooking mood and style. Plus, the convenience of voice control allows for easy adjustments, ensuring the lighting is always perfect, even when your hands are full.

SET THE LIGHTS TO FIT YOUR MOOD

Shelly Plus RGBW PM is designed to sync your lighting with your mood and the flow of your activities. From the focused intensity needed for a home office setup to playful and dynamic lights for a family game night, it has the power to adapt to every part of your day. Save and name your favorite lighting patterns for quick access, ready to be activated with just a simple click or voice command to your assistant.

"NIGHT MODE" FOR SOFT NIGHT LIGHT

Night mode will automatically dial down the brightness and soften the lighting, enhancing your evening routine with just the right touch of light. Set your preferred times and watch your space transition to a gentle illumination that's perfect for winding down after a busy day. This feature also sets the lights' brightness at a low level during the night hours, ensuring that walks to the bathroom at night will no longer irritate your sleepy eyes. Now when the lights are turned on manually, through voice, or a motion sensor, they will always be dimmed and soft.



Wi-Fi and Bluetooth connectivity

Connect Shelly Plus RGBW PM to your Wi-Fi network. No HUB required! Features quick inclusion via Bluetooth.



Power Measurement

Keep track of your energy consumption with precise monitoring capabilities, allowing for efficient energy use without sacrificing quality of lighting.



Color effects

Set the mood by dimming and choose between 16 million colors and unique effects.



Flexible input control

Use it with your existing switches, no matter if they're single, dual or 4-button.



Smart schedules & scenes

Set custom schedules & scenes. Combine Shelly Plus RGBW PM with your other Shelly devices.



Scripting

Fully supports scripting, allowing you local control and custom functionalities.

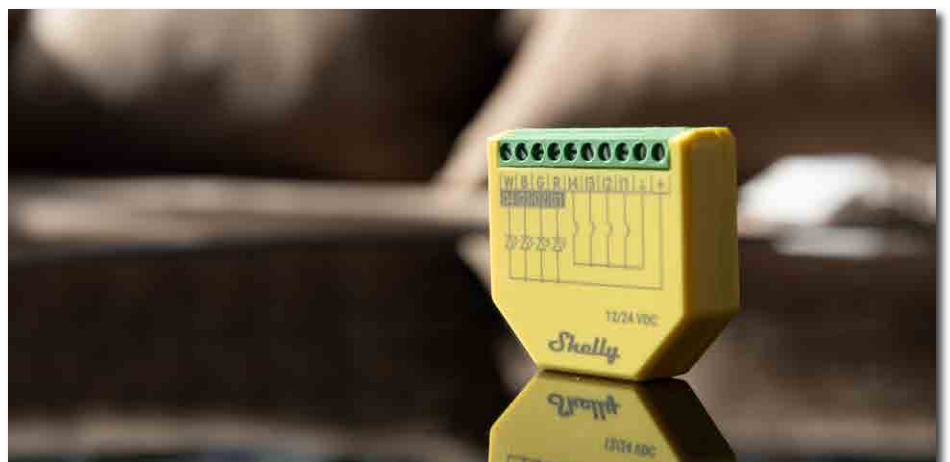

TAILORED LIGHTING WITH ADVANCED PROFILES

The **Shelly Plus RGBW PM** goes beyond traditional lighting solutions by offering three distinct profiles to suit your every need:

RGBW Profile: The best of both worlds. The RGBW profile allows you to seamlessly transition between mood-enhancing and practical white lighting, or even a blend of both for a customized ambience.

RGB Profile: Tailored for those who love to set the scene. The RGB profile offers unified control over your RGB LED strips, allowing you to adjust color and brightness across the entire strip to set the desired mood.

Light Profile: With the Light profile, control up to four independent LED strips, adjusting each one's brightness to suit your precise needs.

TECHNICAL SPECIFICATIONS

Power Supply	• 110-240 VAC, 50/60 Hz
Multi-click support	Up to 16 possible actions (4 per button)
Complies with EU standards	<ul style="list-style-type: none"> • RED 2014/53/EU • EMC 2014/30/EU • RoHS2 2011/65/EU
Working temperature	-20°C to 40°C / -5°F to 105°F
Max RF power	< 20 dBm
Radio protocol	Wi-Fi 802.11 b/g/n
Frequency Wi-Fi	2400 - 2483 MHz
Operational range (depending on local conditions)	<ul style="list-style-type: none"> • Up to 30 m / 100 ft indoors • Up to 50 m / 160 ft outdoors
Dimensions	42x37x12 mm / 1.46x1.65x0.66 in
Power consumption	< 1.2 W
Wire cross section range	0.5 to 1.5 mm ² / 20 to 16 AWG

Legend

Device terminals

+: 12/24 VDC positive terminal

-: 12/24 VDC negative terminal

I1, I2, I3, I4: Switch/button/potentiometer input terminals for light control

R, G, B: Red, Green, and Blue channel outputs (when in "RGB" or "RGBW" mode)

W: White channel output (when in "RGBW" mode)

O1, O2, O3, O4: Light outputs (when in "Lights" mode)

Wires

+: Positive wire

-: Negative wire

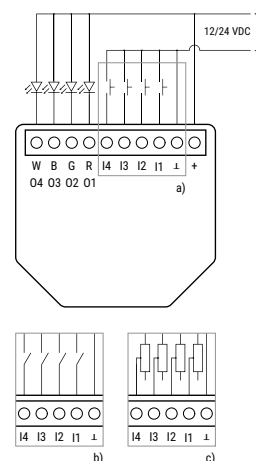

Fig. 1 Wiring in Lights mode

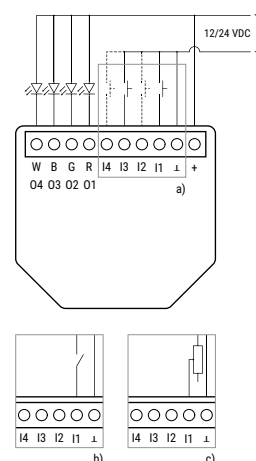

Fig. 2 Wiring in RGBW mode

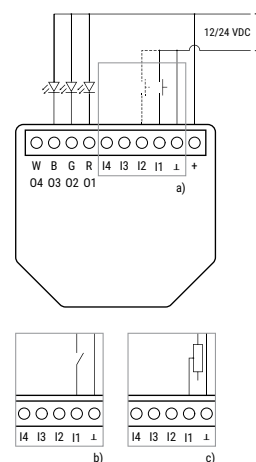
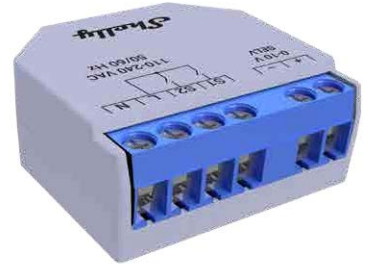

Fig. 3 Wiring in RGB mode

Shelly PLUS

0-10 V Dimmer



BRIGHTNESS THAT SUITS YOUR ACTIVITIES

Depending on your activities and the time of day, different types of light and luminosity are suitable. With Shelly Plus 0-10 V Dimmer, you can align the minimum and maximum brightness levels with your driver's range for exact precision when adjusting your lights. Whether you want to set the ambiance for a relaxing evening or ensure the best brightness for focused tasks, it grants you fine-tuned control to match every moment. No need to navigate through the app - just use your voice!

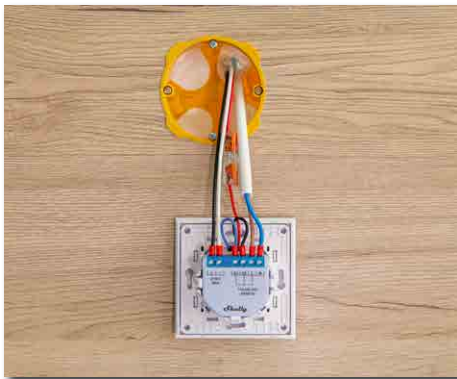

PERSONALIZED LIGHT SCHEDULES

Shelly Plus 0-10 V Dimmer can effortlessly blend with your daily routine. Consider bedtime: Many kids prefer to fall asleep with the lights turned on. You can set schedules that, over an hour, gently dim the room before switching the lights off completely. That way, the little one will be comfortably asleep, and no energy will go to waste!



Wi-Fi operated

Connect Shelly Plus 0-10 V Dimmer to your Wi-Fi network. No HUB required!



Bluetooth

Quick inclusion via Bluetooth or use it as a Bluetooth gateway.



Smart schedules

Set custom schedules based on your daily agenda, or follow the sunrise/sunset and control your lighting accordingly.



Flexible input control

Use it with your existing switches, no matter if they're single or dual button.



Smart scenes

Set custom scenes by combining Shelly Plus 0-10 V Dimmer with your other Shelly devices.



Scripting

Shelly Plus 0-10 V Dimmer fully supports scripting, allowing you local control and custom functionalities.

SMART 0-10 V DIMMER CONTROLLER FOR SEAMLESS LIGHTNING CONTROL

No need to invest in new, specialized dimmer switches that clash with your home's aesthetic. Now, even buttons that weren't originally designed for dimming can work with **Shelly Plus 0-10 V Dimmer**. Seamlessly integrate dimming capabilities into your current setup and enjoy a smart home experience that's truly personalized.

TECHNICAL SPECIFICATIONS

Power Supply	• 110-240 VAC, 50/60 Hz
Max. control voltage	10 V
Max. control current	35 mA
Complies with EU standards	<ul style="list-style-type: none"> • RED 2014/53/EU • LVD 2014/35/EU • EMC 2014/30/EU • RoHS2 2011/65/EU
Working temperature	-20°C to 40°C / -5°F to 105°F
Max RF power	20 dBm
Radio protocol	Wi-Fi 802.11 b/g/n
Frequency	2400 - 2495 MHz
Operational range (depending on local conditions)	<ul style="list-style-type: none"> • Up to 30 m / 100 ft indoors • Up to 50 m / 160 ft outdoors
Dimensions	42x37x16 mm / 1.46x1.65x0.63 in
Electrical consumption	< 1.2 W
CPU	ESP-32
Flash	4 MB
Wire cross section range	0.5 to 1.5 mm ² / 20 to 16 AWG

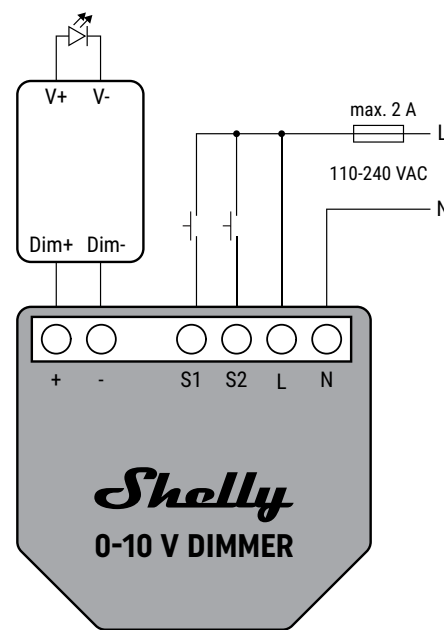

Legend

Device terminals:

- +**: 0-10V positive output
 - : 0-10V negative output
 - S1**: Switch 1 input terminal
 - S2**: Switch 2 input terminal
 - L**: Live terminal
 - N**: Neutral terminal
- Wires:**
- N**: Neutral wire
 - L**: Live (110 - 240 VAC) wire



Shelly ^{PLUS} UNI

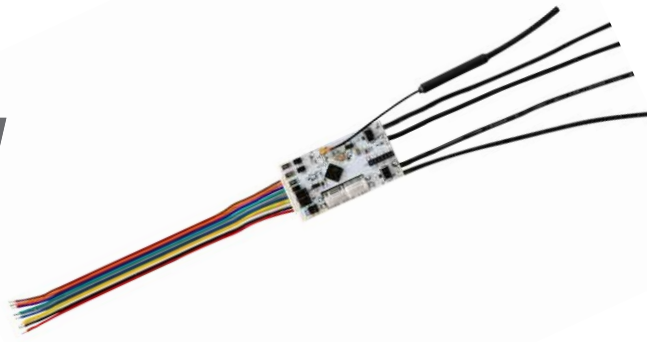

FROM MANUAL TO SMART

Shelly Plus Uni has the unique capability to replace traditional buttons, bringing old appliances into the realm of remote control without the need for replacements. Now, you can easily make your intercom or alarm system smart. Receive instant notifications when someone's at the door and remotely arm or disarm your security system with ease.

ADVANCED SENSOR INTERFACE

Shelly Plus Uni is not just a device; it's a tool to understand your environment better. Use it to measure temperature and humidity with its 1-Wire input, or connect it to a variety of analog and digital sensors. Its capabilities are vast, depending on the sensors you choose.

Healthy garden:

Make sure you water your plants only when needed by connecting a soil moisture sensor.

Water heater and pipes:

Monitor water level, flow, pressure, and temperature to prevent issues and maintain ideal conditions.

Motion-controlled lights:

When connected to a PIR sensor, Shelly Plus Uni can trigger a relay to turn on the lights as soon as you step into the room.

Pool automation:

Maintain pool health with sensors to track water flow, level, pH, chlorine, and temperature, ensuring a safe and enjoyable swim.



Wi-Fi Operated & Bluetooth connectivity

Connect to your Wi-Fi network. No HUB required! Quick inclusion via Bluetooth or use it as a Bluetooth gateway.



Precise Voltmeter

Precise voltage measurement in 2 ranges (0-15 VDC, 0-30VDC)



Sensor interface

Works with various analog and digital sensors



Dry contacts

Two potential-free outputs that can switch up to 28 VDC and 24 VAC



Pulse counting

Receive precise data readings from your energy/gas/water meter



Scripting

Shelly Plus Uni fully supports scripting, allowing you local control and custom functionalities.

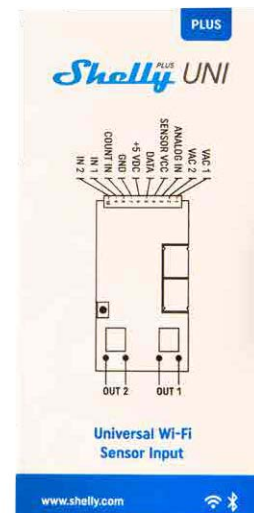
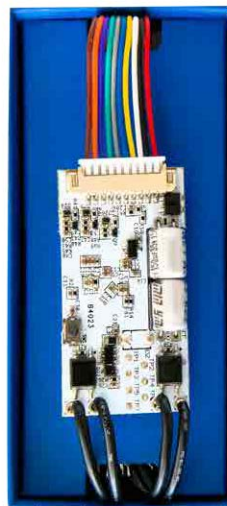

TINY DEVICE, BIG CAPABILITIES

Suitable for low-voltage applications, **Shelly Plus Uni** brings smart functionality to your old appliances. With its new pulse counting feature, you're not just automating – you're getting insightful monitoring of your home's usage. Designed for durability, its transparent cover offers full protection, ensuring both the device and your home appliances are always safe. Powerful in functionality and adaptable to any setting, Shelly Plus Uni seamlessly integrates into your home, unlocking endless possibilities for smart innovation.

TECHNICAL SPECIFICATIONS

Power Supply	<ul style="list-style-type: none"> • 8-24 VAC • 9-28 VDC • 5 VDC (stabilized, via +5 VDC and GND)
Max. control voltage	30 V
Max. control current	300 mA
Complies with EU standards	<ul style="list-style-type: none"> • RED 2014/53/EU • LVD 2014/35/EU • EMC 2014/30/EU • RoHS2 2011/65/EU
Working temperature	-20°C to 40°C / -5°F to 105°F
Max RF power	20 dBm
Radio protocol	Wi-Fi 802.11 b/g/n
Frequency	2400 - 2495 MHz
Operational range (depending on local conditions)	<ul style="list-style-type: none"> • Up to 30 m / 100 ft indoors • Up to 50 m / 160 ft outdoors
Dimensions	40x21x7 mm / 1.57x0.83x0.28 in
CPU	ESP-32
Flash	4 MB
Electrical consumption	< 1 W

STAY CONNECTED TO YOUR GATE AND GARAGE

Now, whether you're at home or away, you can effortlessly operate your gate or garage door with your phone. But it doesn't stop there; the reed-switch provides real-time updates, ensuring you always know if they are securely closed or open. This setup simplifies daily routines, whether it's closing the garage from your office or welcoming guests without leaving your home.

Legend

- VAC1:** 8-24 VAC / 9-28 VDC power supply input
- VAC2:** 8-24 VAC / 9-28 VDC power supply input
- ANALOG IN:** Analog input
- SENSOR VCC:** power supply for 1-Wire sensors output
- DATA:** 1-Wire data signal
- +5 VDC:** 5 VDC positive power supply input
- GND:** Device ground
- COUNT IN:** Counter input
- IN 1:** Digital input 1
- IN 2:** Digital input 2
- OUT 1:** Solid-state relay 1 outputs
- OUT 2:** Solid-state relay 2 outputs

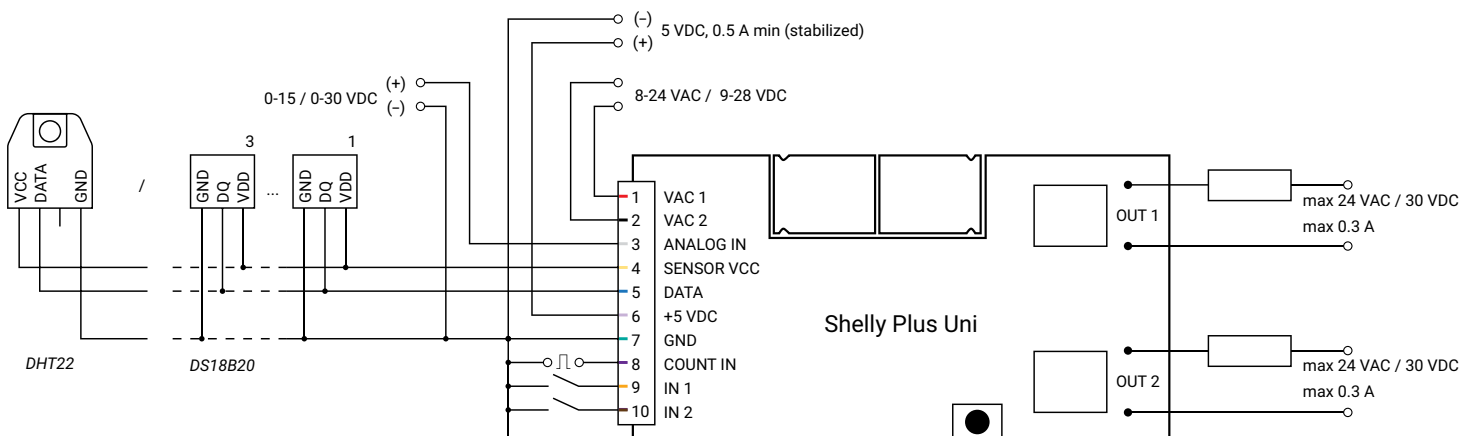

Shelly ^{PLUS} Smoke



BE ALWAYS ALERTED, NO MATTER WHERE YOU ARE!

Provide additional protection for your home, family, and pets with Shelly Plus Smoke. Monitor your home for any smoke, wherever you are, thanks to its long life span, high sensitivity, and Wi-Fi technology.

IMMEDIATE NOTIFICATIONS

Shelly Plus Smoke will immediately inform you and your family members in real-time in case of any detected danger and allow you to take action.

LOCAL CONTROL OF ALL YOUR DEVICES

Shelly Plus Smoke Alarm can execute direct actions on other devices on your local network without being connected to the Internet or Shelly Cloud.



Wi-Fi operated

Connect Shelly Plus Smoke to your Wi-Fi network. No HUB required



Bluetooth connectivity

Easily add Shelly Plus Smoke to your Shelly app account.



3 year of battery life

Low-battery-consuming technology.



Sound & light alerts

If smoke is detected, Shelly Plus Smoke will initiate a loud sound (>85db) and light alarm.



Easily mountable

Shelly Plus Smoke is wire-free and has no angle limitations.



Immediate notification

No matter where you are, Shelly Plus Smoke will immediately notify you of any danger.



Smart scenes

Set custom scenes by combining Shelly Plus Smoke with your other Shelly devices.



No hub required

Control directly and without a hub through your smartphone with Shelly Smart Control App.



Highly compatible

Use with your preferred home automation platforms and voice assistants.

SMART WI-FI SMOKE ALARM

Shelly Plus Smoke Alarm is a smart photoelectric smoke alarm, which is effective at detecting slow fires that smolder for hours before bursting into flame. Receive instant notifications on your phone and create safety scenes to keep your family and home safe.

TECHNICAL SPECIFICATIONS

Battery	1x 3 V CR123A battery
Battery life	3 year
Humidity	30 % to 95 % RH
Weight w/o battery	95 g
Working temperature	0°C to 55°C
Max RF power	20 dBm
Wireless/Wi-Fi Protocol	802.11 b/g/n (2.4 GHz)
Frequency	2400 - 2495 MHz
Operational range (depending on local conditions)	<ul style="list-style-type: none">• Up to 30 m / 100 ft indoors• Up to 50 m / 160 ft outdoors
Dimensions (HxWxL)	86x86x31mm / 3.39x3.39x1.22 in



Shelly ^{PLUS} Wall Dimmer

Available only in US

LIGHTS THAT FOLLOW ANY SCHEDULE

Set smart scenes based on a particular hour or sunset/sunrise with Shelly Plus Wall Dimmer! That way, they can set the lights in the hallway to switch on and increase the level of brightness as the sunset hour approaches.

SMART TIMERS FOR MAXIMUM COMFORT

Many kids prefer to fall asleep with the lights turned on. Shelly Plus Wall Dimmer supports auto-on/off timers that allow customers to set the lights to begin dimming on several stages before they switch off completely. That way, the little one will be comfortably asleep, and no energy will go to waste!

SCRIPTING FOR ENHANCED AUTOMATION

Don't lose the bright light at home when the weather is gloomy and rainy! Thanks to its scripting functionalities, Shelly Plus Wall Dimmer can be adjusted to follow the weather conditions and switch on the lights in your home earlier on rainy days, slowly increasing the brightness as the afternoon turns into the evening.



Wi-Fi operated

Connect Shelly Plus Wall Dimmer to your Wi-Fi network. No HUB required



Bluetooth connectivity

Easily add Shelly Plus Wall Dimmer to your Shelly app account.



Timers and schedules

Automatically follow the sunrise and sunset and control your lighting accordingly.



Automatically calibrated

Allows adjustment of the distance and the movement to which the sensor reacts.



Extremely fast processor

For immediate command execution and notification.



RPC over MQTT, HTTP, UDP

Receive notification in case someone is trying to dislocate it.



Scripting capabilities

JavaScript editor, for customized and complex automation.

LIGHTING CONTROL WITH UL-CERTIFIED WI-FI WALL DIMMER FROM SHELLY

With sleek styling and an intuitive touch slider for dimming and brightening, the new **Shelly Plus Wall Dimmer US** is UL-certified and functions as a standalone device or integrated into virtually any control or automation platform connected directly to Wi-Fi.

Simple 4-wire design, with quick Bluetooth inclusion and automatic calibration, Shelly Plus Wall Dimmer US saves integrators valuable time and eliminates complexity in the smart home installation process.

TECHNICAL SPECIFICATIONS

Power supply voltage AC	100 - 120 V, 50/60 Hz
Power consumption	< 3 W
Humidity	30 % to 70 % RH
Weight without face plate	105 g / 3.70 oz
Ambient temperature	-20°C to 40°C / -5°F to 105°F
Max RF power	20 dBm
Wireless/Wi-Fi Protocol	802.11 b/g/n (2.4 GHz)
Frequency	2400 - 2495 MHz
Operational range (depending on local conditions)	<ul style="list-style-type: none"> • Up to 30 m / 100 ft indoors • Up to 50 m / 160 ft outdoors
Size without face plate and wires (HxWxD)	104x44x39 mm / 4.09x1.73x1.50 in
Size with face plate and without wires (HxWxD)	120x70x39 mm / 4.72x2.76x1.50 in

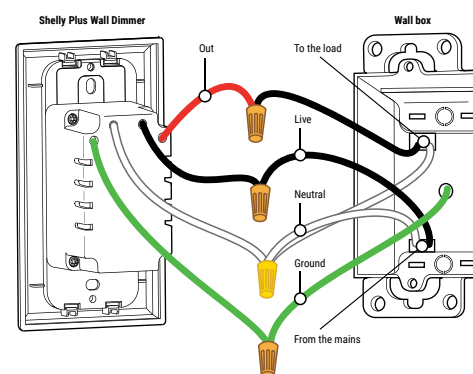

Shelly ^{PLUS} Plug S



AVOID ENERGY WASTE WITH SMART SCHEDULES

Cut the energy consumption in half with Shelly Plus Plug S and reduce monthly energy costs by automating appliances in the office that are not used at night or over the weekend.



WHEN



From 07:00PM - To 7:00 AM

THEN



Shelly Plus Plug S
Switch off Water dispenser

MILDLY DIMMED NIGHT LIGHT FOR CHILDREN'S COMFORT

Use Shelly Plus Plug S LED indication as subtle light for the kids' room at night – just set the colour and the level of glow.



Wi-Fi operated

Connect Shelly Plus Plug S to your Wi-Fi network. No HUB required!



Bluetooth connectivity

Easily add Shelly Plus Plug S to your Shelly app account.



Wide variety of appliances supported

Use it to control a wide range of devices and appliances (up to 12 A)



Power Monitoring

Shelly Plus Plug S provides precise monitoring of power consumption.



3 LED indication modes

Use Shelly App to adjust the brightness of the LED ring according to your preferences in all modes.



Custom schedules

Set custom schedules based on your daily agenda or automatically follow the sunrise/sunset and control your appliances accordingly.



Smart scenes

Set custom scenes by combining Shelly Plus Plug S with your other Shelly devices.



URL actions

Let Shelly Plus Plug S directly control or get controlled by other smart devices.



No hub required

Control directly and without a hub through your smartphone with Shelly Smart Control App.



Highly compatible

Use with your preferred home automation platforms and voice assistants

NEXT-GENERATION WI-FI OPERATED PLUG

Shelly Plus Plug S is a small, but powerful Wi-Fi smart plug with Bluetooth connectivity and power metering, that will monitor and control lighting, heating, or any other connected electrical appliance with a power rating of up to 2500 W at home.

TECHNICAL SPECIFICATIONS

Power supply	Input 110-230 VAC, 50/60 Hz
Max load	12 A / 230 V
Complies with EU standards	<ul style="list-style-type: none">• RED 2014/53/EU• LVD 2014/35/EU• EMC 2014/30/EU• RoHS2 2011/65/EU
Working temperature	-20°C to 40°C / -5°F to 105°F
Max RF power	20 dBm
Wireless/Wi-Fi Protocol	802.11 b/g/n (2.4 GHz)
Frequency	2400 - 2495 MHz
Operational range (depending on local conditions)	<ul style="list-style-type: none">• Up to 30 m / 100 ft indoors• Up to 50 m / 160 ft outdoors
Dimensions (HxWxL)	44x44x70 mm / 1.73x1.73x2.75 in
Processor (CPU)	ESP32
Remote Control	Trough mobile app & web interface
Compatibility	Android (4.2+) & iOS (8+), web browsers
Languages	Multiple trough mobile app & web interface
Electrical consumption	< 1 W

POWER CONSUMPTION LED INDICATION

When set to "Power consumption" mode, Shelly Plus Plug S will indicate the power consumption by a smooth color change from green for 0%, yellow for 50% and red for 100% of the power limit.

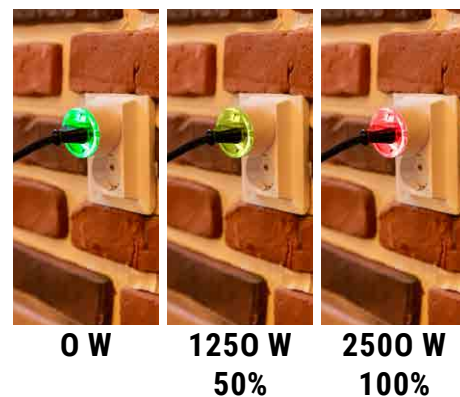

ADJUSTABLE LED LIGHT



Shelly ^{PLUS} Plug UK



FORECAST AND OPTIMIZE YOUR UTILITY EXPENSES

Use the integrated precise power meter of Shelly Plus Plug UK and monitor the real-time energy consumption of all switched-on devices to optimize your expenses.



PREVENT APPLIANCES DAMAGES

You can set Shelly Plus Plug UK to inform you about any damaged electrical appliance, which has increased the amount of energy used in an attempt to compensate for its operational capacity.



ALEXA, TURN ON THE "CHILL TIME" SCENE!

Are you ready for some relaxing time after a long day at work? Just say so and Shelly will make it happen!



Wi-Fi operated

Connect Shelly Plus Plug UK to your Wi-Fi network. No HUB required!



Bluetooth connectivity

Easily add Shelly Plus Plug UK to your Shelly app account.



Wide variety of appliances supported

Use it to control a wide range of devices and appliances (up to 12 A)



Power Monitoring

Shelly Plus Plug UK provides precise monitoring of power consumption.



3 LED indication modes

Use Shelly App to adjust the brightness of the LED ring according to your preferences in all modes.



Custom schedules

Set custom schedules based on your daily agenda or automatically follow the sunrise/sunset and control your appliances accordingly.



Smart scenes

Set custom scenes by combining Shelly Plus Plug UK with your other Shelly devices.



Scripting functionalities

Shelly Plus Plug UK fully supports mJS scripting, allowing you to create further features and functionalities.



URL actions

Let Shelly Plus Plug UK directly control or get controlled by other smart devices.



No hub required

Control directly and without a hub through your smartphone with Shelly Smart Control App.



Highly compatible

Use with your preferred home automation platforms and voice assistants

NEXT-GENERATION WI-FI OPERATED PLUG (UK STANDARD)

Shelly Plus Plug UK is a Wi-Fi smart plug with Bluetooth connectivity, 3 customizable LED indication modes, and power metering. It can automatically monitor and control lighting, heating, or any other connected electrical appliance at home with power up to 2300W.

TECHNICAL SPECIFICATIONS

Power supply	Input 110-230 VAC, 50/60 Hz
Max load	12 A / 230 V
Complies with EU standards	<ul style="list-style-type: none">• RED 2014/53/EU• LVD 2014/35/EU• EMC 2014/30/EU• RoHS2 2011/65/EU
Working temperature	-20°C to 40°C / -5°F to 105°F
Max RF power	20 dBm
Wireless/Wi-Fi Protocol	802.11 b/g/n (2.4 GHz)
Frequency	2400 - 2495 MHz
Operational range (depending on local conditions)	<ul style="list-style-type: none">• Up to 30 m / 100 ft indoors• Up to 50 m / 160 ft outdoors
Dimensions (HxWxL)	60x60x56 mm / 2.36x2.36x2.20 in
Processor (CPU)	ESP32
Remote Control	Trough mobile app & web interface
Compatibility	Android (4.2+) & iOS (8+), web browsers
Languages	Multiple trough mobile app & web interface
Electrical consumption	< 1 W

POWER CONSUMPTION LED INDICATION

When set to "Power consumption" mode, Shelly Plus Plug UK will indicate the power consumption by a smooth color change from green for 0%, yellow for 50% and red for 100% of the power limit.

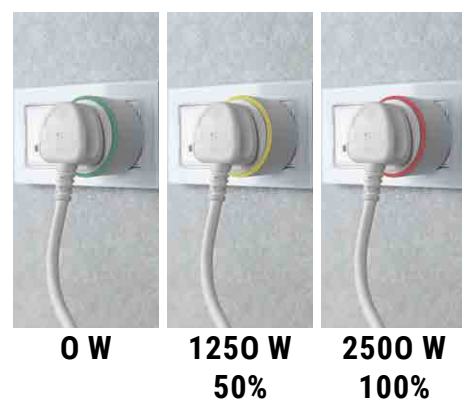

Shelly ^{PLUS} Plug IT



MAKE YOUR OLD SPACE HEATER FOLLOW THE WEATHER

Use Shelly Plus Plug IT's scripting functionalities to automate your old space heater to follow the current weather forecast, so no energy will go to waste.

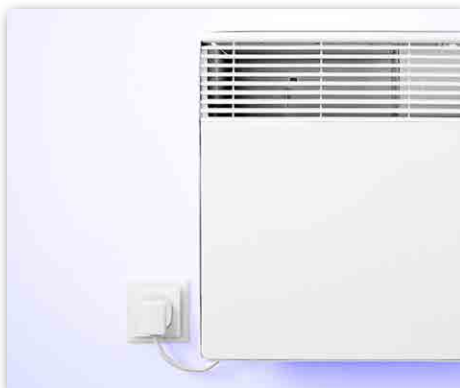

NO MORE FORGOTTEN APPLIANCES

Save energy or prevent any possible damage by controlling all plugged-in appliances easily through your phone with Shelly Plus Plug IT.



Wi-Fi Operated

Connect Shelly Plus Plug IT to your Wi-Fi network. No HUB required!



Bluetooth connectivity

Easily add Shelly Plus Plug IT to your Shelly app account.



Wide variety of appliances supported

Use it to control a wide range of devices and appliances (up to 10A)



Power Monitoring

Shelly Plus Plug IT provides precise monitoring of the power consumption.



Custom schedules

Set custom schedules based on your daily agenda or automatically follow the sunrise/sunset and control your appliances accordingly.



Smart scenes

Set custom scenes by combining Shelly Plus Plug IT with your other Shelly devices.



Countdown timer

An integrated countdown timer for pre-set actions - switch on/off.



URL actions

Let Shelly Plus Plug IT directly control or get controlled by other smart devices.



No hub required

Control directly and without a hub through your smartphone with Shelly Smart Control App.



Highly compatible

Use with your preferred home automation platforms and voice assistants

WI-FI OPERATED PLUG (ITALIAN STANDARD)

Shelly Plus Plug IT is a Wi-Fi smart plug with power metering, that automatically monitors and controls lighting, heating, or any other connected electrical appliance at home with a power rating of up to 2300 W.

TECHNICAL SPECIFICATIONS

Power supply	Input 230 VAC, 50/60 Hz
Max load	10 A / 230 V
Complies with EU standards	<ul style="list-style-type: none">• RED 2014/53/EU• LVD 2014/35/EU• EMC 2014/30/EU• RoHS2 2011/65/EU
Working temperature	-20°C to 40°C / -5°F to 105°F
Max RF power	20 dBm
Wireless/Wi-Fi Protocol	802.11 b/g/n (2.4 GHz)
Frequency	2400 - 2495 MHz
Operational range (depending on local conditions)	<ul style="list-style-type: none">• Up to 30 m / 100 ft indoors• Up to 50 m / 160 ft outdoors
Dimensions (HxWxL)	70x70x70 mm / 2.76x2.76x2.76 in
Processor (CPU)	ESP32
Remote Control	Trough mobile app & web interface
Compatibility	Android (4.2+) & iOS (8+), web browsers
Languages	Multiple trough mobile app & web interface
Electrical consumption	< 1 W



Shelly ^{PLUS} Plug US



Available only in US

MAKE YOUR OLD SPACE HEATER SMART

Controlling the temperature at home has never been easier! There is no need to invest in expensive smart appliances. If you have an old space heater, don't let go of it just yet! Instead, make it smart by simply plugging it into Shelly Plug! Then, create a scene with Shelly Plus H&T and have the heater turn on once the sensor detects a drop in temperature levels. And the cherry on top? You always know how much energy you're consuming!

BUSY SCHEDULE?

Do you work at home? We know how important it is for you to maintain a good and robust Internet connection and do your work professionally and promptly, even remotely.

With Shelly Plus Plug US, you can use a local script to determine when the Internet is down and reboot modems and routers.

ENHANCED SECURITY

It has enhanced security – the support for TLS 1.2 and encrypted firmware for corporate security requirements keeps your data secure when being transferred over a network.

It allows you to turn off computers, printers, copiers, and other office equipment left on overnight or over the weekend and save energy.



Wi-Fi Operated

Connect Shelly Plus Plug US to your Wi-Fi network. No HUB required!



Bluetooth connectivity

Easily add Shelly Plus Plug US to your Shelly app account.



Wide variety of appliances supported

Use it to control a wide range of devices and appliances (up to 15A)



Power Monitoring

Shelly Plus Plug US provides precise monitoring of the power consumption.



Custom schedules

Set custom schedules based on your daily agenda or automatically follow the sunrise/sunset and control your appliances accordingly.



Smart scenes

Set custom scenes by combining Shelly Plus Plug US with your other Shelly devices.



Countdown timer

An integrated countdown timer for pre-set actions - switch on/off.



URL actions

Let Shelly Plus Plug US directly control or get controlled by other smart devices.



No hub required

Control directly and without a hub through your smartphone with Shelly Smart Control App.



Highly compatible

Use with your preferred home automation platforms and voice assistants

THE WI-FI SMART PLUG THAT FITS EVERYWHERE

Shelly Plus Plug US is a Wi-Fi smart plug with power metering, that automatically monitors and controls lighting, heating, or any other connected electrical appliance at home with power up 1800 watts at 15A . Plug your ordinary space heater into Shelly Plus Plug US, so you can switch it on and off at any time, from anywhere with just one click on your phone.

TECHNICAL SPECIFICATIONS

Power supply voltage AC	120 V, 60 Hz
Max switching voltage AC	140 V
Max switching current AC	15 A
Ambient temperature	-20°C to 40°C / -5°F to 105°F
Max RF power	20 dBm
Wireless/Wi-Fi Protocol	802.11 b/g/n (2.4 GHz)
Frequency	2400 - 2495 MHz
Operational range Wi-Fi (depending on local conditions)	<ul style="list-style-type: none">• Up to 30 m / 100 ft indoors• Up to 50 m / 160 ft outdoors
Dimensions (HxWxL)	38x84x52 mm / 1.5x3.3x2.0 in
Processor (CPU)	ESP32
Flash	4 MB
Bluetooth Protocol	4.2
Operational range Bluetooth (depending on local conditions)	<ul style="list-style-type: none">• Up to 10 m / 33 ft indoors• Up to 30 m / 100 ft outdoors
Electrical consumption	< 1 W



Shelly

Wall Display and BLU H&T



pack



SIMPLIFIED CONTROL FROM ONE SPOT!

Shelly Wall Display is a sophisticated 4-inch display that brings intuitive control and seamless monitoring to every corner of your smart home. Whether it's dimming the lights, adjusting the room's ambiance, or ensuring optimal energy efficiency, this smart control panel makes home management simple. The highly customizable home screen becomes a reflection of your preferences, offering a quick glimpse of essential home details. Together with Shelly BLU H&T, it can function as a smart thermostat, allowing you to easily fine-tune your heating or cooling.

A SMART THERMOSTAT FOR YOUR HOME

Shelly Wall Display can also function as a thermostat together with Shelly BLU H&T, presenting an intuitive interface for monitoring, managing, and fine-tuning your heating or cooling settings. It works to craft an optimal energy-efficient experience, no matter how large the room is. Working in harmony with other Shelly devices, it dynamically adjusts your heating or cooling settings to maintain the ideal temperature, ensuring your environment is always comfortable and efficient.



Wi-Fi and Bluetooth connectivity

Connect it to your Wi-Fi network. No HUB required! Quick inclusion via Bluetooth or use it as a Bluetooth gateway.



Innovative Touch Display

4-inch high quality color display



Easy navigation

Scroll through different menus and control your devices with just a tap



Innovative ON/OFF touch control

Tap the display with more than one finger to control the lights



Shelly Smart Control App integration

Control directly and without a hub through your smartphone with Shelly Smart Control App



Scene control and scheduling

Quickly set actions based on your own preferences and agenda



Integrated switch

Features a 5 A switch for appliance control



Bluetooth gateway

A smart Bluetooth to Wi-Fi gateway



Power monitoring

Of all power measuring devices in your chosen room

SHELLY WALL DISPLAY AND BLU H&T

Control all your devices from one centralized place with **Shelly Wall Display**, now combined with **Shelly BLU H&T** for precise climate control. Shelly Wall Display is an intuitive 4" wall display that gives you easy, centralized control and monitoring of all your Shelly devices. With a minimalistic look and customizable home screen, Shelly Wall Display will perfectly fit into your interior and adjust to your needs. Replace your ordinary light switch in 10 minutes and control & monitor all your Shelly devices with just a tap.

TECHNICAL SPECIFICATIONS WALL DISPLAY

Power supply	230 VAC, 50/60 Hz
Max switching current AC	5 A
Complies with EU standards	<ul style="list-style-type: none"> • RED 2014/53/EU • LVD 2014/35/EU • EMC 2014/30/EU • RoHS2 2011/65/EU
Working temperature	-20°C to 40°C / -5°F to 105°F
Max RF power	<20 dBm
Wireless/Wi-Fi Protocol	802.11 b/g/n (2.4 GHz)
Frequency	2400 - 2495 MHz
Operational range W-Fi (depending on local conditions)	<ul style="list-style-type: none"> • Up to 30 m / 100 ft indoors • Up to 50 m / 160 ft outdoors
Operational range Bluetooth (depending on local conditions)	<ul style="list-style-type: none"> • Up to 10 m / 33 ft indoors • Up to 30 m / 100 ft outdoors
Dimensions (HxWxD)	85x85x30 mm / 3.35x3.35x1.18 in
Electrical consumption	< 1 W

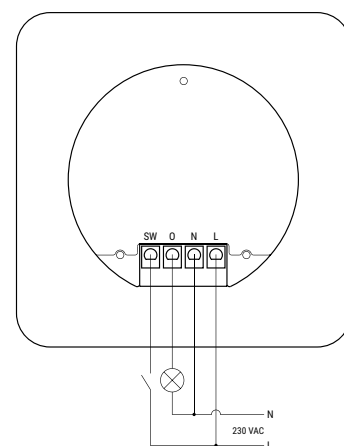

Legend

Device terminals:

- O:** Output terminal
- SW:** Switch input terminal
- L:** Live terminal
- N:** Neutral terminal

Wires:

- N:** Neutral wire
- L:** Live (230 VAC, 50/60 Hz) wire



SUPREME HOME AND FACILITY AUTOMATION WITH SHELLY'S PROFESSIONAL LINE OF DIN-RAIL SMART SWITCHES

Enhanced with overheating, overpower, and overvoltage load protection, Shelly Pro series is designed to be installed inside the breaker box (DIN). Allowing full smart automation with no additional cables or wiring, Shelly Pro line is perfect for homes, offices, stores, business, and manufacturing facilities, as well as new buildings.



CAPABILITIES



CONNECTIVITY



Wi-Fi



Bluetooth



LAN

ENHANCED SAFETY



Temperature protection



Overpower protection (PM devices)



Flame Retardant (V+0)



Overvoltage protection (PM devices)

FEATURES



HTTP/HTTPS webhooks



Sunrise/Sunset actions with offsets



Weekly Scheduling



Custom scripts(mJs)



Grouping



Scenes

Shelly ^{PRO}

AUTOMATION STRAIGHT FROM THE BREAKER BOX

Shelly Pro line allows full automation from the breaker box with minimized additional cables or wiring required. That makes it the perfect solution for new buildings and manufacturing facilities, which you can automate based on your or your business's needs.



PRECISE POWER MEASUREMENT

The PM devices of Shelly Pro line are equipped with ESP32 processor, providing immediate notifications and real-time power consumption measurements.

ENHANCED WITH



HTTP/HTTPS webhooks

Get notifications or control another compatible equipment or 3rd party automation system.



Scripting for custom automation

Get enhanced functionalities and additional processes settings for a specific integration or function.



Weekly scheduling automation

Quickly set actions based on your daily or weekly schedule.



Smart actions for dynamic control

Set Shelly Pro devices to switch on/off the power, based on the Sunset/Sunrise hour and enjoy dynamic control.

Shelly ^{PRO} 1



USE SHELLY PRO 1 for

Shelly Pro 1 is enhanced with scripting functionalities, allowing users to set custom automation scenes based on various occurrences such as weather forecast, wind force forecast, etc.



Lights control



Bathroom fan control



Irrigation system



Pool pump control



LAN, Wi-Fi and Bluetooth

Simultaneous Wi-Fi and LAN usage, add device fast and easy via Bluetooth connection



1 channel switch

1 output, 16 A



Dry Contacts

Supports a wide range of voltages, with dry contacts



Wide range of voltage support

Shelly Pro 1 can be powered by 110-240 VAC



Extremely fast processor

For immediate command execution and notification.



Wide variety of appliances control

Suitable for automating the lights, appliances, irrigation system, pool system, heaters, and many more.



Enhanced safety

Flame retardant shell (V-0) with internal overtemperature protection.



Enhanced security

MQTT and WSS support, TLS and custom certificates support for a broad range of use cases.



No hub required

Control directly and without a hub through your smartphone with Shelly Smart Control App.



Highly compatible

Use with your preferred home automation platforms and voice assistants.

PROFESSIONAL LIGHTS AND APPLIANCES AUTOMATION FOR RESIDENTIAL OR COMMERCIAL USE

Shelly Pro 1 is a one-phase, 1 channel switch supporting up to 16 A. Equipped with potential-free outputs (dry contacts), Shelly Pro 1 offers high flexibility in voltage support and applications. Power it with 110-240 VAC, use scripting functionalities to set custom automation scenes based on various occurrences.

TECHNICAL SPECIFICATIONS

Power supply	110-240 VAC, 50/60 Hz;
Max load	16 A / 15 A UL Version
Complies with EU standards:	<ul style="list-style-type: none"> • RED 2014/53/EU • LVD 2014/35/EU • EMC 2014/30/EU • RoHS2 2011/65/EU
Working temperature	-20°C to 40°C / -5°F to 105°F
Max RF power	13.35 dBm
Wireless/Wi-Fi Protocol	802.11 b/g/n (2.4 GHz)
Frequency	2400 - 2495 MHz
Operational range Wi-Fi (depending on local conditions)	<ul style="list-style-type: none"> • Up to 30 m / 100 ft indoors • Up to 50 m / 160 ft outdoors
Dimensions (HxWxD)	94x19x69 mm / 3.70x0.75x2.71 in
Electrical consumption	< 3 W
Wire cross section range	0.5 to 1.5 mm ² (blue) 0.5 to 2.5 mm ² (green)

HOW TO CONNECT

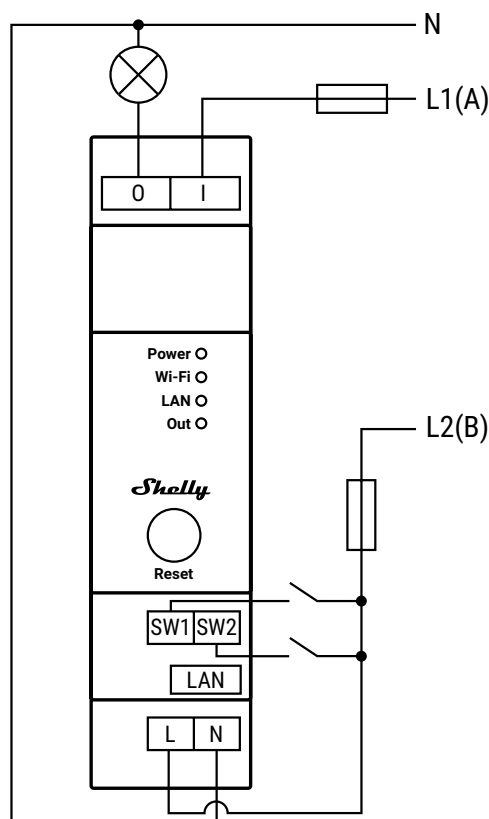

Legend

Device terminals:

O: Load output terminal

I: Load input terminal

SW1, SW2: Switch input terminals controlling O*

L: Live (110-240 VAC) terminal

N: Neutral terminal

LAN: Local Area Network RJ 45 connector

Cables:

N: Neutral cable

L: Live (110-240 VAC) cable

L1(A): Load circuit live (110-240 VAC) cable

L2(B): Device power supply live (110-240 VAC) cable

* Can be reconfigured in the Device settings

Shelly ^{PRO} 1PM



USE SHELLY PRO 1PM for

Shelly Pro 1PM allows customers to automate, measure the power consumption, and analyze data from lights and appliances. Different types of actions, scenarios and schedules can be set to sync your environment to your daily activities or business needs.



Lights control

Laundry machine monitoring



Water heater automation

Floor heating automation



LAN, Wi-Fi and Bluetooth

Simultaneous Wi-Fi and LAN usage, add device fast and easy via Bluetooth connection.



1 channel switch

1 output, 16 A.



Wide range of voltage support

Shelly Pro 1PM can be powered by 110-240 VAC



Power metering with data storage

Integrated precise power meter that allow you to measure the consumption of the lights or appliances.



Wide variety of appliances control

Suitable for automating & measuring the consumption of lights, dishwashers, washing machines, appliances, etc.



Enhanced safety

Flame retardant shell (V-0) with internal overtemperature, over-power and overvoltage protection.



Enhanced security

MQTT and WSS support, TLS and custom certificates support for a broad range of use cases.



No hub required

Control directly and without a hub through your smartphone with Shelly Smart Control App.



Highly compatible

Use with your preferred home automation platforms and voice assistants.

ENHANCED ELECTRICAL APPLIANCES AUTOMATION WITH PRECISE POWER METERING

Shelly Pro 1PM is a one-phase, 1 channel switch supporting up to 16 A. Equipped with integrated power meter, it allows users to measure the precise power consumption of all automated lights or appliances. Shelly Pro 1PM is suitable for automating & measuring the consumption of lights, dishwashers, washing machines, appliances, etc. Power it with 110-240VAC, use scripting functionalities to set custom automation scenes based on various occurrences.

TECHNICAL SPECIFICATIONS

Power supply	110-240 VAC, 50/60 Hz
Max load	16 A / 15 A UL version
Complies with EU standards:	<ul style="list-style-type: none"> • RED 2014/53/EU • LVD 2014/35/EU • EMC 2014/30/EU • RoHS2 2011/65/EU
Working temperature	-20°C to 40°C / -5°F to 105°F
Max RF power	13.34 dBm
Wireless/Wi-Fi Protocol	802.11 b/g/n (2.4 GHz)
Frequency	2400 - 2495 MHz
Operational range Wi-Fi (depending on local conditions)	<ul style="list-style-type: none"> • Up to 30 m / 100 ft indoors • Up to 50 m / 160 ft outdoors
Dimensions (HxWxD)	94x19x69 mm / 3.70x0.75x2.71 in
Electrical consumption	< 3 W
Wire cross section range	0.5 to 1.5 mm ² (blue) 0.5 to 2.5 mm ² (green)

HOW TO CONNECT

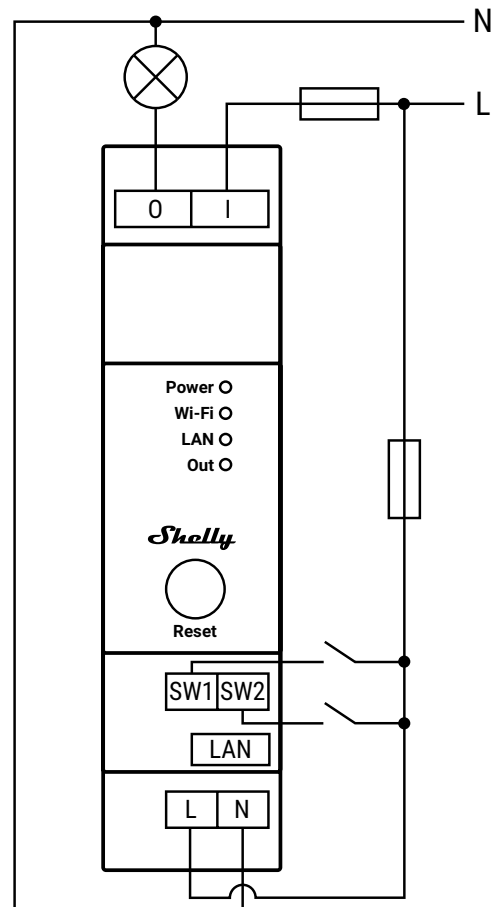

Legend

Device terminals:

O: Load output terminals

I: Load input terminals

SW1, SW2: Switch input terminals controlling O*

L: Live (110-240 VAC) terminal

N: Neutral terminal

LAN: Local Area Network RJ 45 connector

Cables:

N: Neutral cable

L: Live (110 - 240 VAC) cable

* Can be reconfigured in the Device settings

Shelly ^{PRO} 2



USE SHELLY PRO 2 FOR

Shelly Pro 2 is enhanced with scripting functionalities, allowing users to set custom automation scenes based on various occurrences such as weather forecast, wind force forecast, etc.



LAN, Wi-Fi and Bluetooth

Simultaneous Wi-Fi and LAN usage, add device fast and easy via Bluetooth connection



2 channels switch

2 outputs, 16 A each. Total device maximum capacity 25 A.



Dry Contacts

Supports a wide range of voltages, with dry contacts.



Wide range of voltage support

Shelly Pro 2 can be powered by 110-240 VAC



Extremely fast processor

For immediate command execution and notification.



Wide variety of appliances control

Suitable for automating the lights on 2 phases, appliances, pool and heating system, and many more.



Enhanced safety

Flame retardant shell (V-0) with internal overtemperature protection.



Enhanced security

MQTT and WSS support, TLS and custom certificates support for a broad range of use cases.



No hub required

Control directly and without a hub through your smartphone with Shelly Smart Control App.



Highly compatible

Use with your preferred home automation platforms and voice assistants.

APPLIANCES AUTOMATION AND LIGHTS CONTROL ON 2 PHASES!

Shelly Pro 2 is two-phases and 2 channels switch, supporting up to 25 A. Equipped with potential-free outputs (dry contacts), Shelly Pro 2 offers high flexibility in voltage support and applications. Power it with 110-240 VAC, use scripting functionalities to set custom automation scenes based on various occurrences.

TECHNICAL SPECIFICATIONS

Power supply	110-240 VAC, 50/60 Hz
Max load per channel	16 A / 12.5 A UL Version
Total max. current of all outputs	25 A
Complies with EU standards:	<ul style="list-style-type: none"> • RED 2014/53/EU • LVD 2014/35/EU • EMC 2014/30/EU • RoHS2 2011/65/EU
Working temperature	-20°C to 40°C / -5°F to 105°F
Max RF power	13.35 dBm
Wireless/Wi-Fi Protocol	802.11 b/g/n (2.4 GHz)
Frequency	2400 - 2495 MHz
Operational range Wi-Fi (depending on local conditions)	<ul style="list-style-type: none"> • Up to 30 m / 100 ft indoors • Up to 50 m / 160 ft outdoors
Dimensions (HxWxD)	94x19x69 mm / 3.70x0.75x2.71 in
Electrical consumption	< 3 W
Wire cross section range	0.5 to 1.5 mm ² (blue) 0.5 to 2.5 mm ² (green)

HOW TO CONNECT

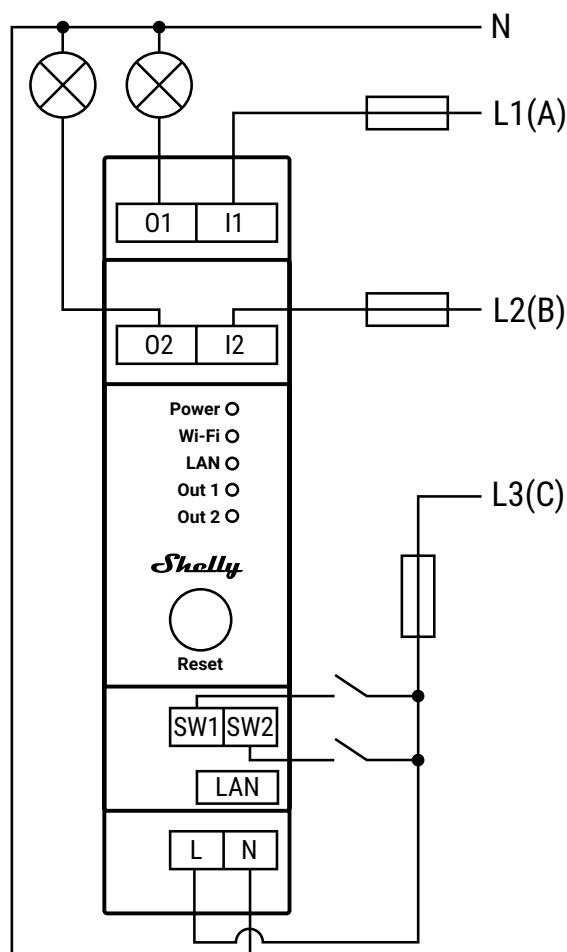

Legend

Device terminals:

- O1, O2:** Load output terminals
- I1, I2:** Load input terminals
- SW1, SW2:** Switch input terminals controlling O1 and O2
- L:** Live (110-240 VAC) terminal
- N:** Neutral terminal
- LAN:** Local Area Network RJ 45 connector

Cables:

- N:** Neutral cable
- L1(A):** Load circuit 1 live (110-240 VAC) cable
- L2(B):** Load circuit 2 live (110-240 VAC) cable
- L3(C):** Device power supply live (110-240 VAC) cable

Shelly ^{PRO} 2PM



USE SHELLY PRO 2PM FOR

Shelly Pro 2PM supports two-directional motor control, which makes it perfect for automation of roller shutters, curtains, awnings, and gates.

Customers can use scripting functionalities to set custom automation scenes based on various occurrences, weather forecast, wind forecast, etc.



Roller shutter automation

Curtains automation



Sliding doors control

Pool cover automation



Office blinds

Gate automation



LAN, Wi-Fi and Bluetooth

Simultaneous Wi-Fi and LAN usage, add device fast and easy via Bluetooth connection



2 channels switch

2 outputs 16A each, total device maximum capacity of 25 A.



Wide range of voltage support

Shelly Pro 2PM can be powered by 110-240 VAC



Power metering with data storage

Two integrated precise power meters that allow you to measure the consumption for each channel separately



Two-directional control

Control any 110-240 VAC bi-directional motor, roller shutters, motorized curtains, or awning



Wide variety of appliances control

Suitable for appliances, roller shutters, awnings, motors up to 600 W, lights on different phases, and many more.



Enhanced safety

Flame retardant shell (V-0) with internal overtemperature, over-power and overvoltage protection.



Enhanced security

MQTT and WSS support, TLS and custom certificates support for a broad range of use cases.



No hub required

Control directly and without a hub through your smartphone with Shelly Smart Control App.



Highly compatible

Use with your preferred home automation platforms and voice assistants.

BLINDERS AND ROLLER SHUTTERS

AUTOMATION WITH PRECISE POWER METERING

Shelly Pro 2PM is a 2 channel switch, supporting up to 16 A per phase with total device capacity of 25 A. Equipped with two integrated precise power meters that allow customers to measure the consumption for each channel separately. Shelly Pro 2PM is suitable for appliances, roller shutters, awnings, motors up to 600 W. Power it with 110-240 VAC, use scripting functionalities to set custom automation scenes based on various occurrences.

TECHNICAL SPECIFICATIONS

Power supply	110-240 VAC, 50/60 Hz
Max load per channel	16 A / 12.5 A UL Version
Total max. current of all outputs	25 A
Complies with EU standards:	<ul style="list-style-type: none"> • RED 2014/53/EU • LVD 2014/35/EU • EMC 2014/30/EU • RoHS2 2011/65/EU
Working temperature	-20°C to 40°C / -5°F to 105°F
Max RF power	13.34 dBm
Wireless/Wi-Fi Protocol	802.11 b/g/n (2.4 GHz)
Frequency	2400 - 2495 MHz
Operational range Wi-Fi (depending on local conditions)	<ul style="list-style-type: none"> • Up to 30 m / 100 ft indoors • Up to 50 m / 160 ft outdoors
Dimensions (HxWxD)	94x19x69 mm / 3.70x0.75x2.71 in
Electrical consumption	< 3 W
Wire cross section range	0.5 to 1.5 mm ² (blue) 0.5 to 2.5 mm ² (green)

HOW TO CONNECT

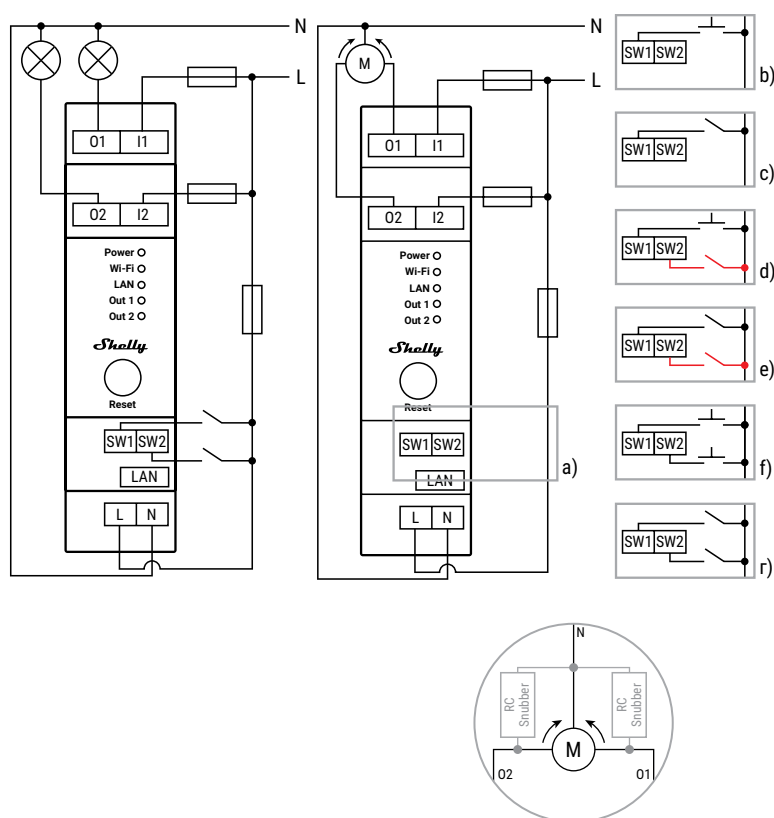

Legend

Device terminals:

O1, O2: Load output terminals

I1, I2: Load input terminals

SW1, SW2: Switch input terminals controlling O1 and O2

L: Live (110-240 VAC) terminal

N: Neutral terminal

LAN: Local Area Network RJ 45 connector

Cables:

N: Neutral cable

L: Live (110-240 VAC) cable

Shelly ^{PRO} 4PM



USE SHELLY PRO 4PM FOR

With the power to control and power measure a variety of appliances, Shelly Pro 4PM can work standalone or be complementary to any existing automation project in your home or office.



Office lights

Ventilation control



Office outlets

Heating system



AC motor pumps control

Load shedding control



LAN connection

Enhanced with LAN connection for even more stable connection.



Wi-Fi operated

Connect Shelly Pro 4PM to your Wi-Fi network.



Bluetooth connectivity

Add devices quickly and easily via Bluetooth connection, using Shelly Smart Control App.

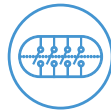

4 channels

4 outputs, 16A each, total device maximum of 40 A.



Screen with navigation keys

1.8-inch color screen for quick switch control and settings update.



Power metering with data storage

Four integrated precise power meters that allow you to measure the consumption for each channel separately.



Wide variety of appliances control

Suitable for controlling and measuring the consumption of lights, appliances, pool system heaters, and many more.



Enhanced safety

Flame retardant shell (V-0) with internal overtemperature, over-power and overvoltage protection.



Enhanced security

MQTT and WSS support, TLS certificate support and management for a broad range of use cases.



No hub required

Control directly without a hub through your smartphone with Shelly Smart Control App.



Highly compatible

Use with your preferred home automation platforms and voice assistants.

SUPREME HOME AND FACILITY AUTOMATION STRAIGHT FROM THE BREAKER BOX

4-channel DIN-mountable smart switch with Wi-Fi, Bluetooth and LAN connectivity. **Shelly Pro 4PM** is enhanced with temperature, overpower, and overvoltage load protection. It allows full automation for residential, commercial, and other applications.

TECHNICAL SPECIFICATIONS

Power supply	110-240 VAC, 50/60 Hz
Max load per channel	16 A
Total max. current of all outputs	40 A
Complies with EU standards:	<ul style="list-style-type: none"> • RED 2014/53/EU • LVD 2014/35/EU • EMC 2014/30/EU • RoHS2 2011/65/EU
Working temperature	0°C to 40°C / 32°F to 105°F
Max RF power	13.83 dBm
Wireless/Wi-Fi Protocol	802.11 b/g/n (2.4 GHz)
Frequency	2400 - 2495 MHz
Operational range Wi-Fi (depending on local conditions)	<ul style="list-style-type: none"> • Up to 30 m / 100 ft indoors • Up to 50 m / 160 ft outdoors
Dimensions (HxWxD)	96 x 53 x 59 mm / 3.78 x 2.01 x 2.32 in
Electrical consumption	< 4 W

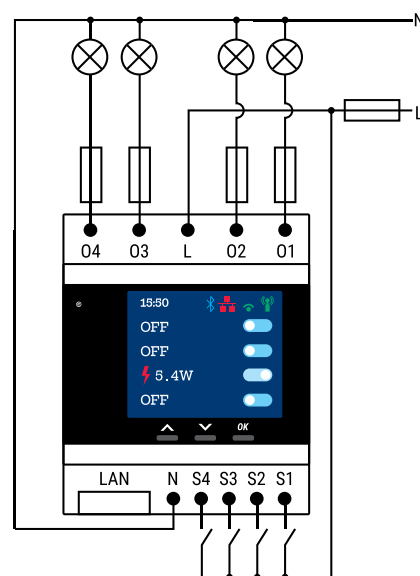

Legend

N - Neutral input / cable (Zero);
L - Live input / cable (110-240 VAC);
L* - Input of O1, O2, O3, O4;
O1, O2, O3, O4 - Output 1, 2, 3, 4;
S1, S2, S3, S4 - Switch inputs controlling O1, O2, O3, O4
LAN - Local Area Network RJ 45 connector
**The cables connected to L must be with the same lenght!*



Shelly^{PRO} 3



USE SHELLY PRO 3 FOR:

You can use Shelly pro 3 to set different types of actions, scenes, and schedules and sync your environment to your daily activities or business needs. Additionally, Shelly Pro 3 has scripting functionalities for custom automation scenes based on external data or various occurrences.

COMMON AREA TEMPERATURE CONTROL



COMMON SPACES LIGHTS AUTOMATION



LAN, Wi-Fi and Bluetooth

Simultaneous Wi-Fi and LAN usage, add device fast and easy via Bluetooth connection

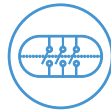

3 channel

Up to 16 A per channel with up to 48 A total device maximum.



Dry Contacts

Use a wide range of output voltage levels. Supports low voltages.



Wide range of voltage support

Use it to control a wide range of AC devices and appliances.

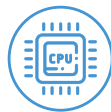

Extremely fast processor

For immediate command execution and notification.



Wide variety of appliances control

Suitable for automating the lights, irrigation system, heaters, and many more.



Enhanced safety

Flame retardant shell (V-0) with internal overtemperature, over-power and overvoltage protection.



Enhanced security

MQTT and WSS support, TLS and custom certificates support for a broad range of use cases.



No hub required

Control directly and without a hub through your smartphone with Shelly Smart Control App.



Highly compatible

Use with your preferred home automation platforms and voice assistants

PROFESSIONAL 3-CHANNEL DIN RAIL SWITCH WITH DRY CONTACTS

Shelly Pro 3 is a three-phase, 3-channel switch supporting up to 48 A for professional lights and appliance automation for residential or commercial use. It is equipped with potential-free outputs (dry contacts) offering high flexibility in voltage support and applications.

TECHNICAL SPECIFICATIONS

Power supply	110-240 VAC, 50/60 Hz
Max load per channel	16 A
Total max. current of all outputs	48 A
Complies with EU standards:	<ul style="list-style-type: none"> • RED 2014/53/EU • LVD 2014/35/EU • EMC 2014/30/EU • RoHS2 2011/65/EU
Working temperature	-20°C to 40°C / -5°F to 105°F
Max RF power	15.93 dBm
Wireless/Wi-Fi Protocol	802.11 b/g/n (2.4 GHz)
Frequency	2400 - 2495 MHz
Operational range Wi-Fi (depending on local conditions)	<ul style="list-style-type: none"> • Up to 30 m / 100 ft indoors • Up to 50 m / 160 ft outdoors
Dimensions (HxWxD)	96x53x59 mm / 3.78x2.01x2.32 in
Electrical consumption	< 3 W

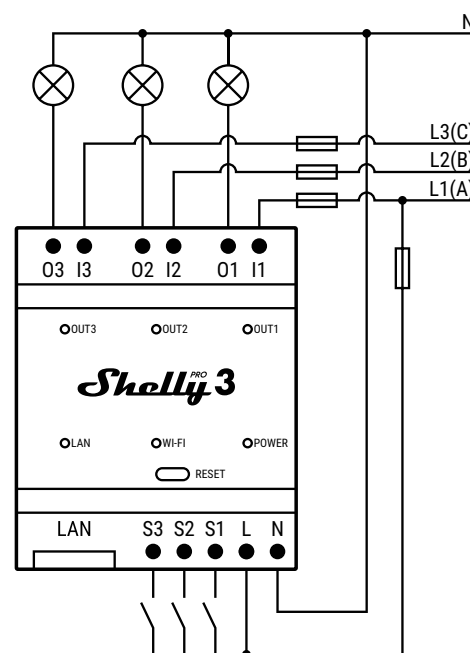

Legend

Device terminals:

- O1, O2, O3:** Load output terminals
 - I1, I2, I3:** Load input terminals
 - SW1, SW2, SW3:** Switch input terminals controlling O1, O2 and O3
 - L:** Live (110-240 VAC) terminals
 - N:** Neutral terminal
 - LAN:** Local Area Network RJ 45 connector
- Cables:**
- N:** Neutral cable
 - L1(A):** Load circuit 1 live (110-240 VAC) cable
 - L2(B):** Load circuit 2 live (110-240 VAC) cable
 - L3(C):** Load circuit 3 live (110-240 VAC) cable



Shelly ^{PRO} 3EM

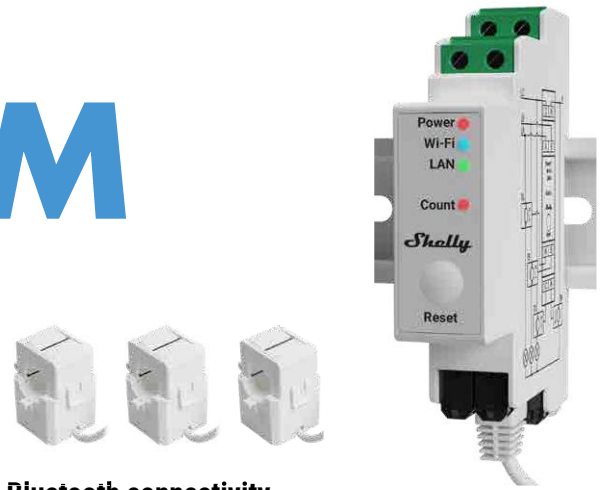

INDUSTRY-GRADE SECURITY

Shelly Pro 3EM supports mTLS for MQTT, HTTP, and secure outbound WebSockets, allowing for direct connections to your cloud infrastructure, reducing the cost of deploying complex networks and VPNs.



INDUSTRIAL INSTALLATIONS

Shelly Pro 3EM brings support for MODBUS for voltage, current, power, and energies. You can accurately sample your energy usage and instantaneous values of voltage, current, and power.



SOLAR PANELS MONITORING AND CONTROL

Save effortlessly by keeping track of how much energy your solar panels or wind turbines are generating. With Shelly Pro 3EM you can get real-time information about the efficiency of the solar and wind energy system.



Wi-Fi, LAN, and Bluetooth connectivity

Simultaneous Wi-Fi and LAN usage, add device fast and easily via Bluetooth connection



4-quadrant measurement

Measure capacitive and inductive load types of active imported and exported energies.



Accuracy class B (active energy)

Shelly Pro 3EM has a measurement accuracy of 1%.



MODBUS support

Allows for easy and fast deployment in existing industrial installations.



Power monitoring

Monitors mono-phase electrical systems with up to 3 points simultaneously. Fast notifications and at least 60 days of 1-minute records storage.



Scripting functionalities

Shelly Pro 3EM fully supports mJS scripting, allowing you to create further features and functionalities.



Enhanced safety

Flame retardant shell (V-0) with internal overtemperature, over-power and overvoltage protection.



Enhanced security

MQTT and WSS support, TLS and custom certificates support for a broad range of use cases.



No hub required

Control directly and without a hub through your smartphone with Shelly Smart Control App.



Highly compatible

Use with your preferred home automation platforms and voice assistants

NEXT-GENERATION DIN-MOUNTABLE 3-PHASE ENERGY METER

Shelly Pro 3EM is a DIN rail mountable three-phase energy meter. Enhanced with all the Gen 2 firmware flexibility and LAN connectivity, it provides professional integrators with additional options for end-customer solutions. Shelly Pro 3EM reports accumulated energy as well as instantaneous voltage, current, and power factor per phase in real time.

TECHNICAL SPECIFICATIONS

Power supply	110-240 VAC, 50/60 Hz
Voltmeters (RMS for each phase)	100 - 260 V
Voltmeters accuracy	±1 %
Ammeters (RMS via CT for each phase and the Neutral)	0 - 120 A
Complies with EU standards	<ul style="list-style-type: none"> • RED 2014/53/EU • LVD 2014/35/EU • EMC 2014/30/EU • RoHS2 2011/65/EU
Working temperature	-20°C to 40°C / -5°F to 105°F
Max RF power Wi-Fi	15 dBm
Wireless/Wi-Fi Protocol	802.11 b/g/n (2.4 GHz)
Frequency	2400 - 2495 MHz
Operational range Wi-Fi (depending on local conditions)	<ul style="list-style-type: none"> • Up to 30 m / 100 ft indoors • Up to 50 m / 160 ft outdoors
Dimensions (HxWxD)	94x19x69 mm / 3.70x0.75x2.71 in

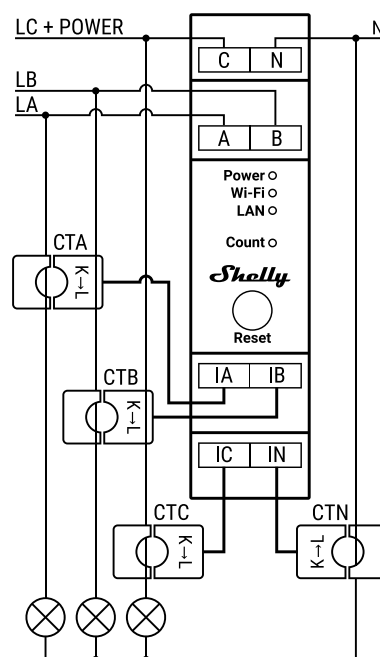

Legend

Device terminals:

- A:** Phase A input
- B:** Phase B input
- C:** Phase C and Device power supply input
- N:** Neutral input
- IA:** Phase A current transformer (CTA) input
- IB:** Phase B current transformer (CTB) input
- IC:** Phase C current transformer (CTC) input
- IN:** Neutral current transformer (CTN) input

Cables:

- LA:** Phase A (110-240 VAC)
- LB:** Phase B (110-240 VAC)
- LC:** Phase C (110-240 VAC)
- N:** Neutral cable

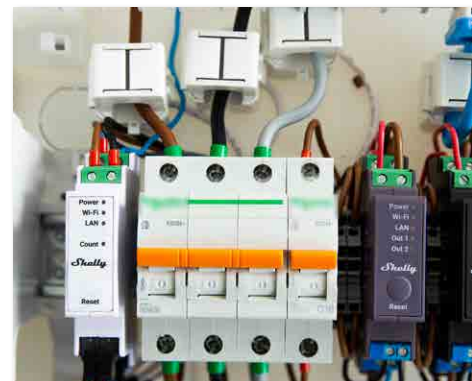

Shelly Pro 3EM-400

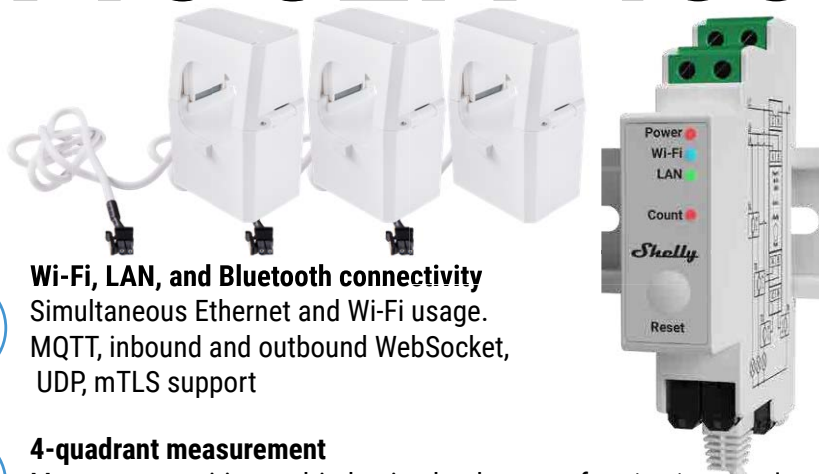

INDUSTRIAL INSTALLATIONS

Shelly Pro 3EM-400 brings support for MODBUS for voltage, current, power, and energies. You can accurately sample your energy usage and instantaneous values of voltage, current, and power. Our new firmware platform allows for custom implementation that can report as fast as every 100ms to your infrastructure.



SOLAR PANELS MONITORING AND CONTROL

Keep track of how much energy your solar panels or wind turbines are generating and save effortlessly. Shelly Pro 3EM-400 provides real-time information about the efficiency of the solar and wind energy system, as well as historical data on how much energy has been generated and consumed every minute for the past 60 days.



LOCAL CONTROL

Thanks to Shelly Pro 3EM-400's scripting functionalities and webhooks, you can now easily control other Shelly or Wi-Fi devices on your local network. Use these capabilities to set exact parameters for heating, cooling, or electric vehicle charging based on PV production and have your devices automatically shed power usage. All these work without using a cloud.



Wi-Fi, LAN, and Bluetooth connectivity

Simultaneous Ethernet and Wi-Fi usage. MQTT, inbound and outbound WebSocket, UDP, mTLS support



4-quadrant measurement

Measure capacitive and inductive load types of active imported and exported energies



Accuracy class B (active energy)

Shelly Pro 3EM-400 has a measurement accuracy of 1%



MODBUS support

Allows for easy and fast deployment in existing industrial installations.



Power monitoring

Monitors mono-phase electrical systems with up to 3 points simultaneously. Fast notifications and at least 60 days of 1-minute records storage.



Scripting functionalities

Shelly Pro 3EM-400 fully supports mJS scripting, allowing you to create further features and functionalities.



Enhanced safety

Flame retardant shell (V-0) with internal overtemperature, over-power and overvoltage protection.



Enhanced security

MQTT and WSS support, TLS and custom certificates support for a broad range of use cases.



No hub required

Control directly and without a hub through your smartphone with Shelly Smart Control App.



Highly compatible

Use with your preferred home automation platforms and voice assistants

WHY SHELLY PRO 3EM-400?

NEXT-GENERATION 3-PHASE ENERGY METER

Shelly Pro 3EM-400 is a Wi-Fi-operated DIN-mountable 3-Phase Energy Meter with Wi-Fi, Bluetooth, and LAN connectivity. With active energy measurement accuracy of 1%, Shelly Pro 3EM-400 can be used to monitor the consumption of home appliances, business electric circuits, and office equipment individually. It features 60 days of on-device historical data with a 1-minute resolution for each phase. Additionally, its scripting functionalities allow for the execution of complex scenes and provide broader monitoring abilities.

TECHNICAL SPECIFICATIONS

Power supply	110-240 VAC, 50/60 Hz
Voltmeters (RMS for each phase)	100 - 260 V
Voltmeters accuracy	±1 %
Ammeters (RMS via CT for each phase and the Neutral)	0 - 400 A
Complies with EU standards:	<ul style="list-style-type: none"> • RED 2014/53/EU • LVD 2014/35/EU • EMC 2014/30/EU • RoHS2 2011/65/EU
Working temperature	-20°C to 40°C / -5°F to 105°F
Max RF power Wi-Fi	15 dBm
Wireless/Wi-Fi Protocol	802.11 b/g/n (2.4 GHz)
Frequency	2400 - 2495 MHz
Operational range Wi-Fi (depending on local conditions)	<ul style="list-style-type: none"> • Up to 30 m / 100 ft indoors • Up to 50 m / 160 ft outdoors
Dimensions (HxWxD)	94x19x69 mm / 3.70x0.75x2.71 in

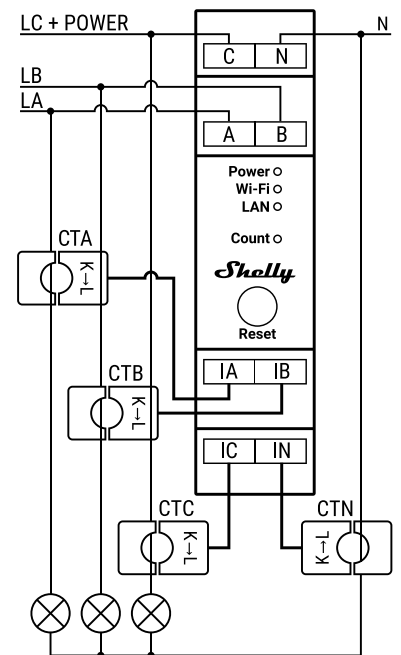

Legend

Device terminals:

- A:** Phase A input
- B:** Phase B input
- C:** Phase C and Device power supply input
- N:** Neutral input
- IA:** Phase A current transformer (CTA) input
- IB:** Phase B current transformer (CTB) input
- IC:** Phase C current transformer (CTC) input
- IN:** Neutral current transformer (CTN) input

Cables:

- LA:** Phase A (110-240 VAC)
- LB:** Phase B (110-240 VAC)
- LC:** Phase C (110-240 VAC)
- N:** Neutral cable

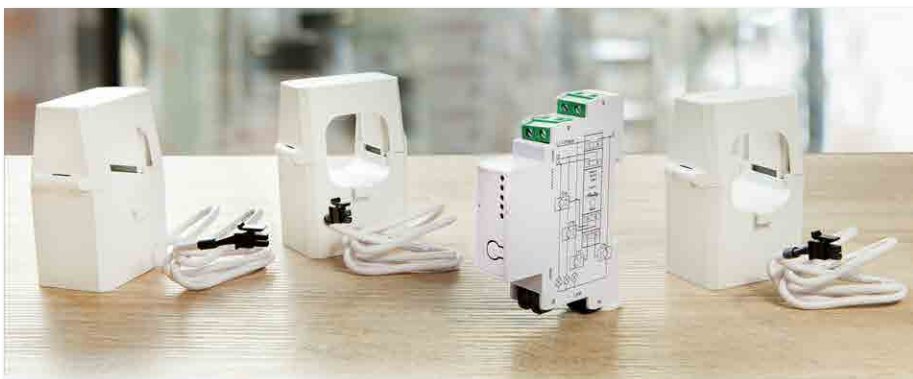

Shelly Pro EM-50



PERFECT FOR SMALL AND MEDIUM BUSINESS OWNERS

If you are a small or medium business owner, you have probably struggled with energy overconsumption. Some machines and appliances are switched on all the time. With Shelly PRO EM 50, you can measure with utmost precision and reduce consumption by turning off load - cold water dispensers, laminating machines, and lighting during the night. The device can also be applied for preventative measurement by monitoring for abnormal behavior of HVAC, air compressors, refrigerator units, and others.

RENEWABLE ENERGY ECOSYSTEM AT HOME

If you have a PV system at home, Shelly PRO EM 50 can help you measure grid and imported energy from renewable sources. Moreover, it has configurable load control, which allows you to redirect any excess energy generated from renewable sources to electronic devices at your home and optimize your energy consumption.



Wi-Fi, LAN, and Bluetooth connectivity
Simultaneous Ethernet and Wi-Fi usage.



DIN rail mountable



Two measured channels



Built-in dry contact switch



MQTT, HTTP, WebSocket transports of data



TLS 1.2 security



Modbus TCP protocol support



Embedded configuration and monitoring web interface



Real-time clock

WHY SHELLY PRO EM-50?

Shelly Pro EM-50 is a DIN rail mountable two-channel, single-phase energy meter. Enhanced with all the gen2 firmware flexibility and LAN connectivity, it provides professional integrators with additional options for end-customer solutions. It can work standalone in a local LAN and/or Wi-Fi network, or it can also be operated through cloud home automation services through MQTT, HTTP, and WebSocket. All inbound connections support TLS.

TECHNICAL SPECIFICATIONS

Power supply	110-240 VAC, 50/60 Hz
Voltmeters (RMS for each phase)	100 - 260 V
Voltmeters accuracy	±1 %
Ammeters (RMS via CT for each phase and the Neutral)	0 - 50 A
Complies with EU standards:	<ul style="list-style-type: none"> • RED 2014/53/EU • LVD 2014/35/EU • EMC 2014/30/EU • RoHS2 2011/65/EU
Working temperature	-20°C to 40°C / -5°F to 105°F
Max RF power Wi-Fi	15 dBm
Wireless/Wi-Fi Protocol	802.11 b/g/n (2.4 GHz)
Frequency	2400 - 2495 MHz
Operational range Wi-Fi (depending on local conditions)	<ul style="list-style-type: none"> • Up to 30 m / 100 ft indoors • Up to 50 m / 160 ft outdoors
Dimensions (HxWxD)	94x19x69 mm / 3.70x0.75x2.71 in

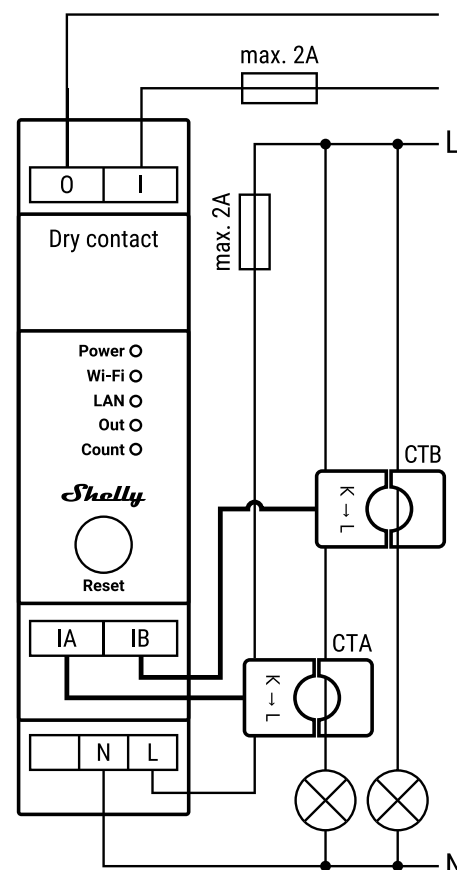

Legend

Device terminals:

O: Relay output

I: Relay input

IA: Current transformer A (CTA) input

IB: Current transformer B (CTB) input

N: Neutral terminal

L: Live (110-240 VAC) terminal

Cables:

N: Neutral cable

L: Live (110-240 VAC) cable



Shelly

PRO 3EM SWITCH ADD-ON



LOAD SHEDDING

Keep track of how much energy your solar panels and wind turbines are generating and save effortlessly by controlling your consumption with Shelly Pro 3EM Add-on. Connect Shelly Pro Add-On to your appliances and use Shelly Pro 3EM's real-time information on how much energy has been generated and consumed. When you need to save energy, Shelly Pro3EM Add-on can automatically switch off non-essential appliances in your home.

WEATHER-BASED CONTROL

Shelly Pro 3EM, enhanced with the Shelly Pro 3EM Add-on, offers weather-driven energy optimization. By scripting, you can efficiently control your appliances based on the weather forecast. Upon receiving real-time weather updates, Shelly Pro 3EM takes measures as defined in the script. For example, if the forecast indicates that it's going to be a sunny day, Shelly Pro 3EM Add-On can automatically turn off the heating anticipating higher temperatures.

PV SYSTEMS BALANCING

When your PV system is producing more energy than your home consumes, Shelly Pro 3EM Add-On can automatically activate appliances to make use of it. For example, you can set it to turn on your water heater, charging station for electric vehicles, or other energy-intensive appliances. This way, you make the most of the abundant energy generated by your PV system and reduce dependency on the grid.



DIN rail mountable
attached to a Shelly Pro 3EM



Dry contacts
A galvanically isolated switch designed to expand the capabilities of your Shelly Pro 3EM devices



WHY SHELLY PRO 3EM SWITCH ADD-ON?

A galvanically isolated switch designed to expand the capabilities of your Shelly Pro 3EM device. This add-on allows you to easily control contactors and other electrical devices, giving you greater flexibility and control over your consumption.

Only compatible with Shelly Pro 3EM devices!

TECHNICAL SPECIFICATIONS

Power supply DC	3.3 V and 12 V (from Shelly Pro 3EM device)
Mounting	DIN rail, attached to a Shelly Pro 3EM
Working temperature	-20°C to 40°C / -5°F to 105°F
Humidity	30 % to 70 % RH
Max switching voltage AC	240 V
Max switching voltage DC	30 V
Max switching current AC	2 A
Max switching current DC	2 A
Power consumption	< 1 W
Dimensions (HxWxD)	94x19x69 mm / 3.70x0.75x2.71 in

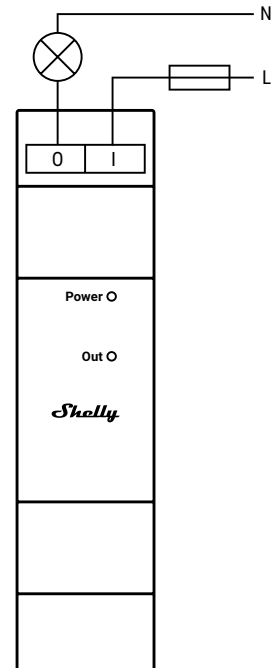
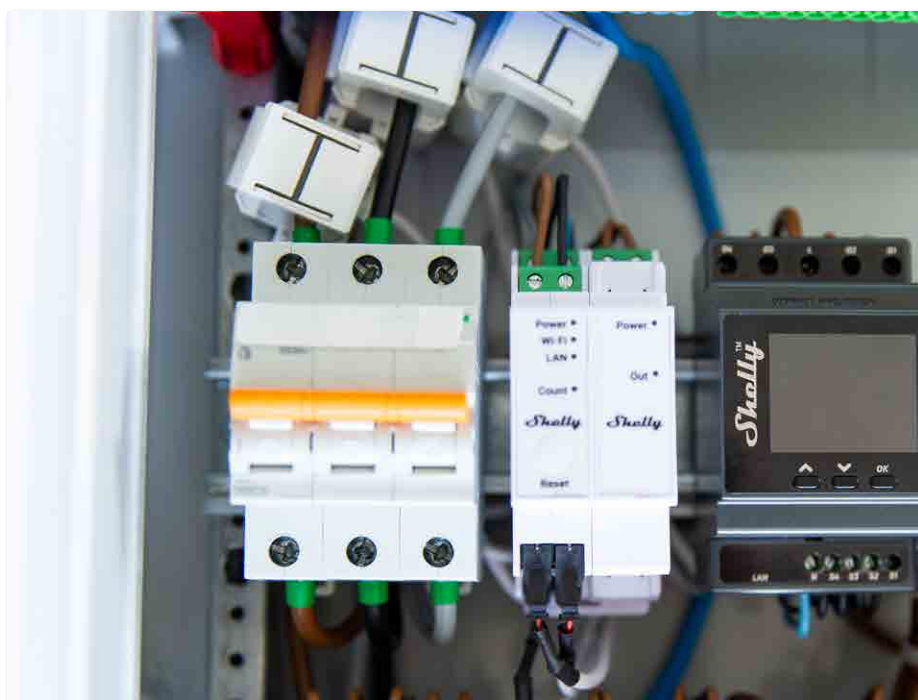

Legend

Device terminals:

O: Relay output terminal

I: Relay input terminal

Cables:

N: Neutral cable

L: Live (110 - 240 VAC) cable



Pro Dual Cover/Shutter PM



Overheating protection

In case of unsafe temperature levels or rapid temperature increase, device switches off the outputs and sends notification.

Overpower protection

Detected overpower will lead to outputs switch off by the device and it will immediately send a notification.

Overvoltage protection*

To avoid damage to the electrical appliances the device switches off the outputs when overvoltage peaks are detected and immediately sends a notification.

**Feature is available only for power metering-enabled devices*



Automated blinds

Control motorized blinds, curtains, and roller shutters to improve privacy, energy efficiency, and home security.



LAN, Wi-Fi, and Bluetooth connectivity

LAN connection for high security and reliability. Simultaneous Wi-Fi and LAN usage, as backup when needed.



Cover (roller) control

Control two bi-directional AC motors and set your desired position.



Precise power metering

Shelly Pro Dual Cover / Shutter PM provides precise monitoring of the power consumption of both covers.



2 covers, 16 A each

Shelly Pro Dual Cover / Shutter PM has a total device output of 32A.



Enhanced safety & security

Improved safety features and TLS 1.2 support, allowing a broad range of secure cloud-connected and local integrations.



Scripting capabilities

Set custom scenes by combining Shelly Pro Dual Cover / Shutter PM with your other devices.

Remote control of parking gates

Shelly Pro Dual Cover / Shutter PM can give you remote control over your parking barriers or gate doors and ensure that only authorized individuals can operate them. You can schedule the gate to open during specific times of the day. Additionally, you can integrate gate control with other smart devices, such as outdoor lighting or surveillance cameras.

An awning that follows the weather

Automatically close the outside awnings to protect them from the wind. Additionally, if the weather forecast predicts, Shelly Pro Dual Cover / Shutter PM will open the awnings again to protect the outside seated customers.

WHY SHELLY PRO DUAL COVER / SHUTTER PM?

DUAL CONTROL, ONE SOLUTION!

This smart controller is supporting up to 16A load per cover. **Shelly Pro Dual Cover/Shutter PM** is equipped with integrated precise power meters that allow you to control and monitor the consumption of each cover separately. It is perfect for the automation of roller shutters, curtains, awnings, gates, and many more.

TECHNICAL SPECIFICATIONS

Power supply	110-240 VAC, 50/60 Hz
Max load per cover	16 A
Total max. current of all outputs	32 A
Complies with EU standards:	<ul style="list-style-type: none"> • RED 2014/53/EU • LVD 2014/35/EU • EMC 2014/30/EU • RoHS2 2011/65/EU
Working temperature	-20°C to 40°C / -5°F to 105°F
Max RF power	< 20 dBm
Wireless/Wi-Fi Protocol	802.11 b/g/n (2.4 GHz)
Frequency	2400 - 2495 MHz
Operational range Wi-Fi (depending on local conditions)	<ul style="list-style-type: none"> • Up to 30 m / 100 ft indoors • Up to 50 m / 160 ft outdoors
Dimensions (HxWxD)	96x53x59 mm / 3.78x2.01x2.32 in
Electrical consumption	< 3 W

Legend

Device terminals:

O1, O2: Cover 1 and Cover 2 output terminal pairs

▲, ▼: Cover direction output terminals

S1, S2: Switch/button input terminals for controlling Cover 1

S3, S4: Switch/button input terminals for controlling Cover 2

L: Live (110-240 VAC) terminal

N: Neutral terminal

LAN: Local Area Network RJ 45 connector

Cables:

N: Neutral cable

L: Live (110-240 VAC) cable

HOW TO CONNECT

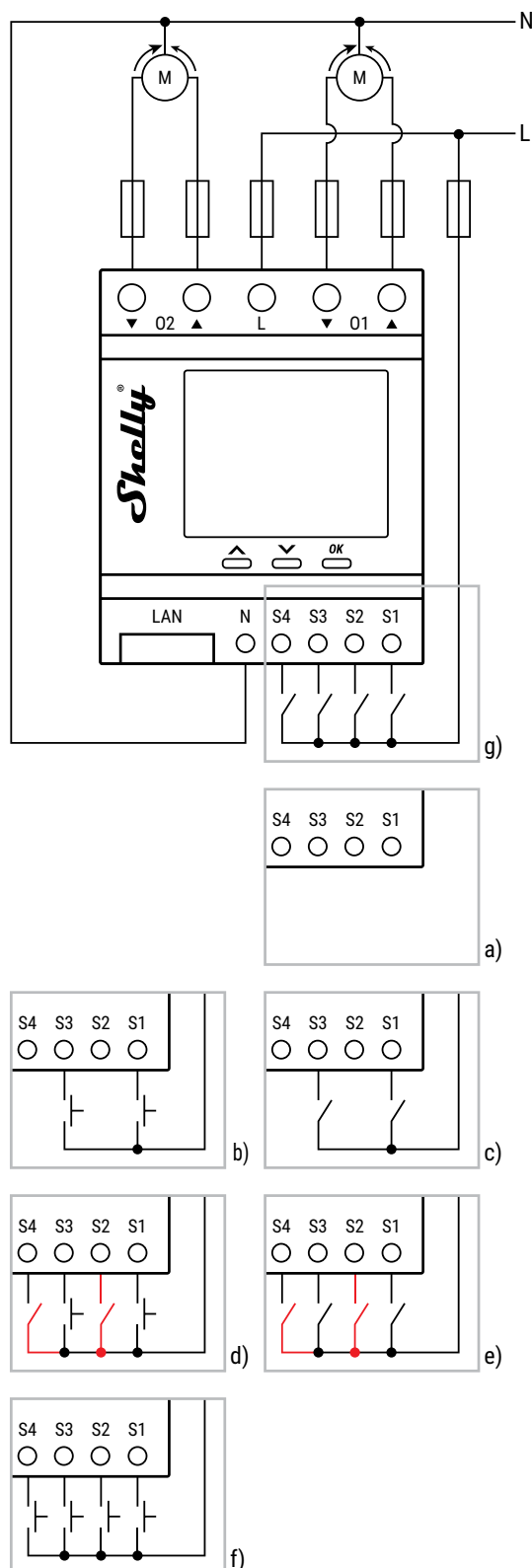

Shelly^{PRO} Dimmer 1PM



Brightness that suits your activities

Shelly Pro Dimmer 1PM gives your fine-tuned control to tailor your lighting to perfection. Set the minimum and maximum brightness levels to match both your personal preferences and the capabilities of your bulbs, ensuring that the lighting in your home is always just right. But the Shelly Pro Dimmer 1PM offers more than just customized brightness. It also allows you to pre-set your preferred lighting scenes for various activities and moods. Whether you want to set the ambiance for a relaxing evening or ensure the best brightness for focused tasks, simply use your existing wall switch to swiftly transition between your chosen atmospheres.

Lights that follow the sun

Give your facility a beautiful exterior and provide the necessary safety by controlling your outdoor and driveway lights. Shelly Pro Dimmer 1PM can help you reduce their energy consumption by dimming them down to 30% after 10 PM.



LAN, Wi-Fi and Bluetooth

LAN connection for high security and reliability. Simultaneous Wi-Fi and LAN usage, as backup when needed.



Light intensity adjustment

Use the dimming function to set the brightness of your lights to your preference.



Power Monitoring

Shelly Pro Dimmer 1PM provides precise monitoring of power consumption.



Flexible input control

Use it with your existing switches, no matter if they're single or dual button.



Smart schedules

Set custom schedules based on your daily agenda or follow the sunrise/sunset and control your lighting accordingly.



Smart scenes

Set custom scenes by combining Shelly Dimmer2 with your other Shelly devices.

THE BEST SOLUTION FOR NEW HOME BUILDINGS AND BUSINESS FACILITIES

Shelly Pro Dimmer 1PM is a DIN-rail mountable, one-channel smart dimmer with power monitoring. Use it to control, dim, and power measure a wide range of halogen lights, dimmable LED, and ferromagnetic transformers between 110-240V. Different types of actions, scenarios, and schedules can be set to sync your lighting environment to your daily activities or business needs.

TECHNICAL SPECIFICATIONS

Power supply	110-240 VAC, 50/60 Hz
Max. output power	200 W
Complies with EU standards:	<ul style="list-style-type: none"> • RED 2014/53/EU • LVD 2014/35/EU • EMC 2014/30/EU • RoHS2 2011/65/EU
Working temperature	-20°C to 40°C / -5°F to 105°F
Max RF power	20 dBm
Wireless/Wi-Fi Protocol	802.11 b/g/n (2.4 GHz)
Frequency	2400 - 2495 MHz
Operational range Wi-Fi (depending on local conditions)	<ul style="list-style-type: none"> • Up to 30 m / 100 ft indoors • Up to 50 m / 160 ft outdoors
Dimensions (HxWxD)	94x19x69 mm / 3.70x0.75x2.71 in
Electrical consumption	< 2 W
Wire cross section range	0.5 to 2.5 mm ² / 20 to 14 AWG (green connectors) 0.5 to 1.5 mm ² / 20 to 16 AWG (blue connector)

Supported load types

HV LED lamps (Dimmable): 200 W
 Dimmable electronic transformers: 180 W
 HV LED lamps (Non Dimmable): 110 W (On/Off mode)
 Incandescent Light bulbs: 200 W
 HV halogen lamp: 200 W
 Wound transformer: 200 VA
 CFL: 50 W

HOW TO CONNECT

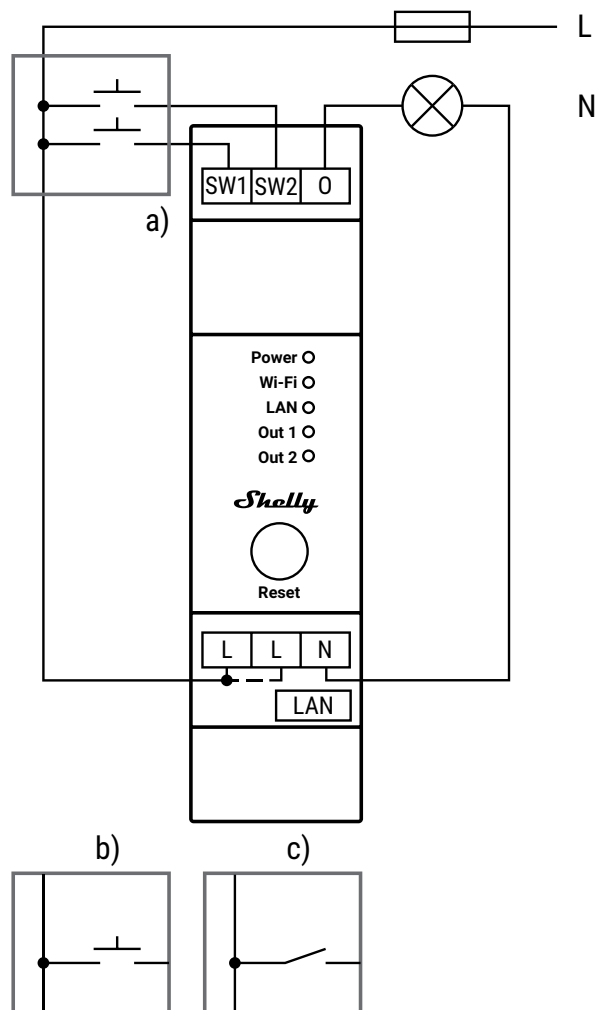

Legend

Device terminals:

SW1 and SW2: Switch input terminals controlling O

O: Load circuit output terminal

L: Live terminal

N: Neutral terminal

LAN: Ethernet RJ45 connector

Wires:

N: Neutral wire

L: Live (110 - 240 V~ 50/60 Hz) wire

Shelly^{PRO} Dimmer 2PM



Optimized energy consumption

Shelly Pro Dimmer 2PM stands as an ideal solution for various dimming and power-metering needs - from expansive multi-room residences to the sophisticated demands of hotels or big office spaces. As part of the professional line series, the device is engineered for seamless integration into a DIN Rail enclosure, which allows you to precisely control and monitor the lights in different rooms. Thus, you can plan your business expenses better, and strategically optimize the energy consumption for enhancing efficiency and cost-effectiveness.

Brightness that suits your activities

Shelly Pro Dimmer 2PM gives your fine-tuned control to tailor your lighting to perfection. Set the minimum and maximum brightness levels to match both your personal preferences and the capabilities of your bulbs, ensuring that the lighting in your home is always just right. But the Shelly Pro Dimmer 2PM offers more than just customized brightness. It also allows you to pre-set your preferred lighting scenes for various activities and moods. Whether you want to set the ambiance for a relaxing evening or ensure the best brightness for focused tasks, simply use your existing wall switch to swiftly transition between your chosen atmospheres.



LAN, Wi-Fi and Bluetooth

LAN connection for high security and reliability. Simultaneous Wi-Fi and LAN usage, as backup when needed.



Light intensity adjustment

Use the dimming function to set the brightness of your lights to your preference.



Power Monitoring

Shelly Pro Dimmer 2PM provides precise monitoring of power consumption.



Flexible input control

Use it with your existing switches, no matter if they're single or dual button.



Smart schedules

Set custom schedules based on your daily agenda or follow the sunrise/sunset and control your lighting accordingly.



Smart scenes

Set custom scenes by combining Shelly Dimmer2 with your other Shelly devices.

THE BEST SOLUTION FOR NEW HOME BUILDINGS AND BUSINESS FACILITIES

Shelly Pro Dimmer 2PM is a DIN-rail mountable, two-channel smart dimmer with power monitoring. Use it to control, dim, and power measure a wide range of halogen lights, dimmable LED, and ferromagnetic transformers between 110-240V. Different types of actions, scenarios, and schedules can be set to sync your lighting environment to your daily activities or business needs.

TECHNICAL SPECIFICATIONS

Power supply	110-240 VAC, 50/60 Hz
Max. output power	200 W
Complies with EU standards:	<ul style="list-style-type: none"> • RED 2014/53/EU • LVD 2014/35/EU • EMC 2014/30/EU • RoHS2 2011/65/EU
Working temperature	-20°C to 40°C / -5°F to 105°F
Max RF power	20 dBm
Wireless/Wi-Fi Protocol	802.11 b/g/n (2.4 GHz)
Frequency	2400 - 2495 MHz
Operational range Wi-Fi (depending on local conditions)	<ul style="list-style-type: none"> • Up to 30 m / 100 ft indoors • Up to 50 m / 160 ft outdoors
Dimensions (HxWxD)	94x19x69 mm / 3.70x0.75x2.71 in
Electrical consumption	< 2 W
Wire cross section range	0.5 to 2.5 mm ² / 20 to 14 AWG (green connectors) 0.5 to 1.5 mm ² / 20 to 16 AWG (blue connector)

Supported load types

HV LED lamps (Dimmable): 200 W
 Dimmable electronic transformers: 180 W
 HV LED lamps (Non Dimmable): 110 W (On/Off mode)
 Incandescent Light bulbs: 200 W
 HV halogen lamp: 200 W
 Wound transformer: 200 VA
 CFL: 50 W

HOW TO CONNECT

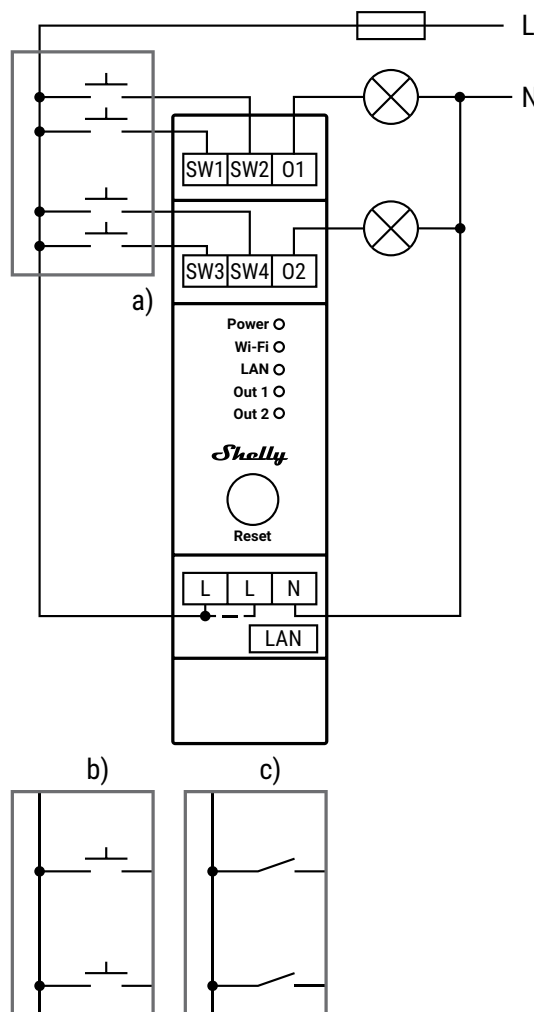

Legend

Device terminals:

SW1 and SW2: Switch input terminals controlling O1

SW3 and SW4: Switch input terminals controlling O2

O1: Load circuit 1 output terminal

O2: Load circuit 2 output terminal

L: Live terminal

N: Neutral terminal

LAN: Ethernet RJ45 connector

Wires:

N: Neutral wire

L: Live (110 - 240 V~ 50/60 Hz) wire

Shelly LAN Switch

LAN DIN-mountable switch

Shelly LAN Switch is a DIN-mountable Ethernet switch with 5 RJ45 ports. It offers a seamless solution to expand your network capabilities without the hassle of extensive rewiring. Engineered for reliability and performance, it ensures a consistent and stable direct network connection to your devices, providing you with peace of mind and confidence in your network infrastructure.

- DIN-mountable
- 5 RJ45 ports
- 10/100mbps
- LED indicators
- 110V - 230 V power supply; No need for additional adapters

Stable connection to your essential devices

No more worrying about lost connections or interruptions - Shelly LAN Switch keeps your smart home running smoothly. Designed to seamlessly integrate with your existing Pro devices, it provides a stable and uninterrupted connection to all your essential appliances, such as your HVAC system and lighting. For homeowners with PV systems, Shelly LAN Switch grants a reliable connection for data gathering, facilitating precise energy monitoring.



DIN-mountable

Designed to meet the global DIN rail standardization and fit perfectly with all your Pro relays



Direct AC Power

Power the device at 110-230 V, eliminating the need for adapters.



Plug & Play

Hassle-free installation and configuration, allowing you to quickly set up and optimize your network.



THE FORM FACTOR YOU ALREADY LOVE

Shelly LAN Switch provides a straightforward solution for reliable connection without the need for extensive electrical modifications. Now, you only need 1 LAN cable inside your breaker box to connect your devices! Its shared form-factor with our Pro line devices ensures it fits perfectly in a Shelly-occupied breaker box, simplifying installation and maintaining an organized setup.

TECHNICAL SPECIFICATIONS

Power supply	110-240 VAC, 50/60 Hz
Mounting	DIN-rail
Working temperature	-20°C to 40°C / -5°F to 105°F
Dimensions (HxWxD)	96x53x59 mm / 3.78x2.01x2.32 in
Power consumption	< 1 W
Wire cross section range	0.5 to 2.5 mm ² / 20 to 14 AWG

HOW TO CONNECT

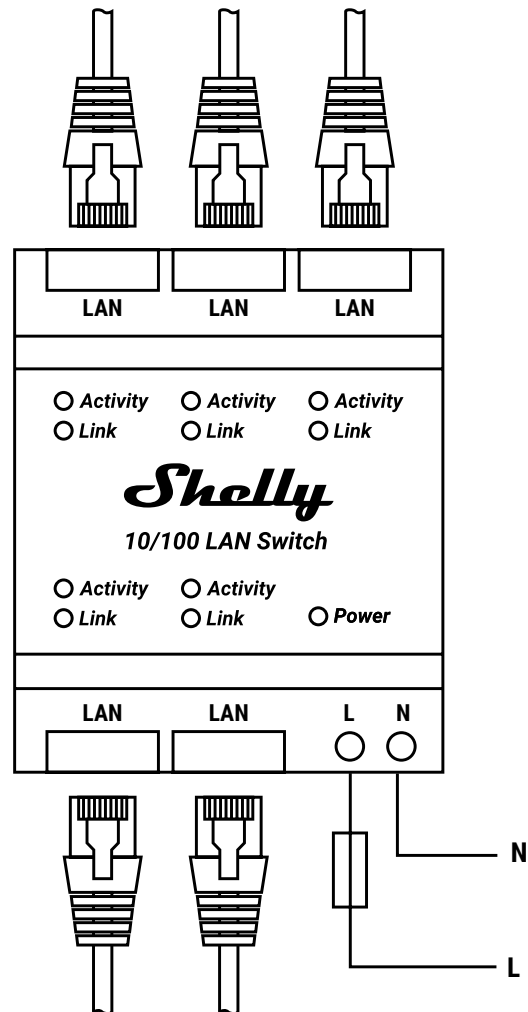

Legend

Device terminals

N: Neutral terminal

L: Live terminal (110-240 VAC)

LAN: Local Area Network RJ 45 connector

Wires

N: Neutral wire

L: Live wire (110-240 VAC)



Shelly^{BLU} H&T



BATHROOM HUMIDITY CONTROL

Maintain a healthy environment in your bathroom with Shelly BLU H&T. Its level of protection guarantees that exposure to steam and splashes won't compromise the device's performance, making it the perfect bathroom companion. By integrating the sensor with Shelly Plus 1 wired to your bathroom fan, you can automate humidity control with ease. Set a scene where, upon detecting high humidity levels, Shelly Plus 1 activates the fan, effectively reducing moisture.



SMART CLIMATE CONTROL

Maintain your home's comfort efficiently. When placed outdoors, Shelly BLU H&T can act as an early warning system and ensure your home adapts to changing weather conditions. Set it to trigger automations - activate the heating system or close the blinds to maintain your desired indoor temperature.



Bluetooth-operated

Quicker response, longer battery life, and easy inclusion



Protection level 54

Water and dust resilient, suitable for indoor and outdoor use



Long-lasting battery

Battery life of up to 3 years, depending on daily usage



Measures temperature & humidity

Reports real-time changes in temperature and humidity



Free data history

Features up to 1 year of free data storage for analysis and statistics



Scene activation

Set custom scenes by combining Shelly BLU H&T with your other Shelly devices

BLUETOOTH-OPERATED TEMPERATURE & HUMIDITY SENSOR

Shelly BLU H&T is a water and dust resilient Bluetooth sensor that precisely measures temperature and humidity levels, both crucial for maintaining a comfortable and healthy environment. When integrated with additional Shelly devices, it enables smooth climate control automation, enhancing the overall comfort and well-being within your space.

TECHNICAL SPECIFICATIONS

Power supply	1x 3 V CR2032 battery (included)
Battery life	up to 3 years
Ambient temperature	-20 °C to 60 °C / -5 °F to 140 °F
Humidity	0% to 100% RH
Protection class	IP54
Encryption	AES encryption (CCM mode)
Beacon mode	Yes
Shell material	Plastic
Color	Black, Mocha, Ivory
Operational range (depending on local conditions)	<ul style="list-style-type: none">• Up to 10 m / 33 ft indoors• Up to 30 m / 100 ft outdoors
Dimensions (HxWxD)	37x37x10 mm / 1.46x1.46x0.39 in
Weight with the battery	13 g

BUSINESS AND STORAGE SOLUTIONS

Shelly BLU H&T excels in professional settings, offering reliable monitoring for storage rooms, server rooms, and other business environments. Its IP65 level of protection ensures that dust and moisture won't compromise the sensor's performance. With its long battery life and strong build, businesses can rely on Shelly BLU H&T for continuous, accurate monitoring to safeguard valuable assets.



Shelly^{BLU} Button Tough 1

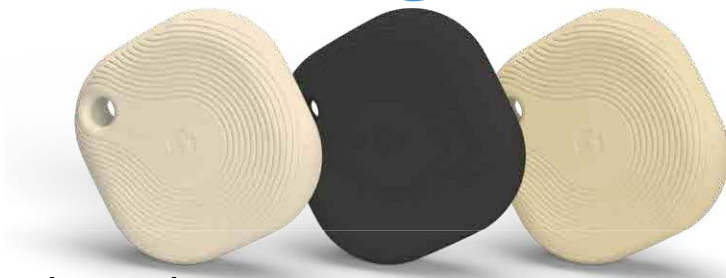

BLUETOOTH-OPERATED SMART BUTTON

Shelly BLU Button Tough1 is a durable action and scenes activation button. Enjoy remote control without relying on your mobile phone. With intuitive click combinations, you can execute up to 4 pre-set actions or scenes with ease, simplifying your smart home control.

- Able to turn on/off appliances, dim, and activate scenes
- Scripting functionality for endless actions based on location
- Full compatibility with Home Assistant and any other device which is supported by BTHome protocol
- Uses BLE technology
- Encryption (high level of security)
- Sound alerts and "Hush" mode for no sounds
- "Find me" function activated by beacon mode
- Range of 10 m indoors and 30 m outdoors
- Works with Plus and Pro devices



Bluetooth-operated

Quicker response, longer battery life, and easy inclusion



Multi-click action trigger

Execute up to 4 pre-set actions or scenes with simple click combinations



Level of protection 54

Shock, water and dust resilient, making it perfect for outdoor use



Immediate response time

Response time of less than 1 second



Broad range

Shelly BLU Button Tough1 has a range of 10m indoors and 30m outdoors



Scene activation

Set custom scenes by combining Shelly BLU Button Tough1 with your other Shelly devices

WATER AND DUST RESILIENT

Designed for the active and adventurous, Shelly BLU Button Tough1 meets the highest standards for durability. With a highest protection level, it is built to resist shock, water and dust, making it reliable in any environment. Its tough exterior is nearly unbreakable, ensuring you stay connected to your smart home even in the harshest conditions.

TECHNICAL SPECIFICATIONS

Power supply	1x 3 V CR2032 battery (included)
Battery life	up to 2 years
Ambient temperature	-20 °C to 60 °C / -5 °F to 140 °F
Humidity	0% to 90% RH
Protection class	IP54
Encryption	AES encryption (CCM mode)
Beacon mode	Yes
Shell material	Plastic
Color	Black, Mocha, Ivory
Operational range (depending on local conditions)	<ul style="list-style-type: none">• Up to 10 m / 33 ft indoors• Up to 30 m / 100 ft outdoors
Dimensions (HxWxD)	42x42x13 mm / 1.65x1.65x0.51 in
Weight with the battery	15 g



ONE DEVICE, EVERY ROOM

Easily manage your smart home devices by creating customized actions that suit your preferences. You can control an entire room with a simple button click, using four distinct push combinations! Assign these combinations to a variety of actions, from turning off lights to adjusting blinds or controlling the garage door. Use the Shelly Smart Control app to pre-set desired actions let your imagination flow with no limits.

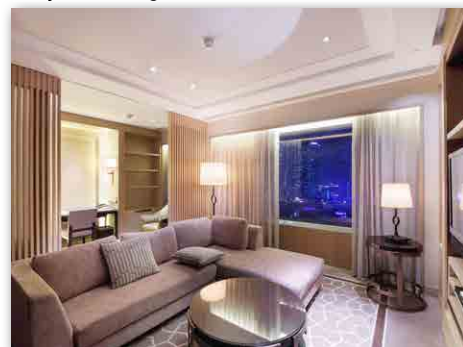

SET THE RIGHT BRIGHTNESS AND POSITION

Quickly transform your space the way you like it. Its simple click combinations simplify control and can instantly adjust the lighting to suit your activities. Beyond lighting, it offers customizable control over your curtains or blinds, enabling you to program different press combinations for 75%, 50%, 25%, or fully open/close positions. Create a cozy atmosphere for movie night or brighten your workspace for enhanced productivity with just a click!

Shelly ^{BLU} Button 1



SCRIPTING

Every Shelly Plus and Pro device in your home with an enabled Bluetooth connection acts as a gateway of the Shelly BLU Button1 signal. With the scripting functionalities of the Shelly Plus and Pro devices you can easily create complex local actions. Based on RSSI, you can fully customize and automate your smart home.

Furthermore, you can use the same button to trigger different actions in multiple locations



INCREASED SECURITY

With support for the Advanced Encryption Standard all communications are encrypted and secure which ensures that even if someone attempts to intercept your device's communication, they will not be able to access your data or compromise your security.



Bluetooth-operated

Use Shelly BLU Button1 to activate Shelly Plus and Pro devices



Multi-click action trigger

Execute up to 4 pre-set actions or scenes with simple click combinations



Immediate response time

Response time fewer than 1 second



Low battery consumption

Up to 2 years, perfect for those who are always on-the-go



Visual & Sound hints

Sound and color indications inform you of its status and help you find it



Broad range

Shelly BLU Button1 has a range of 10 m indoors and 30 m outdoors

WHY SHELLY BLU BUTTON1?

ONE CLICK TO A SMARTER HOME

You can quickly control your smart devices with just a click. Simply set it up and place it wherever you need it most. Whether you want to turn off the lights, adjust your blinds, or lock your front door, BLU Button1 puts the power of your smart home at your fingertips.

Remotely control and activate/deactivate different scenes and other Shelly devices without your mobile phone. Execute up to 4 pre-set actions or scenes with simple click combinations.

TECHNICAL SPECIFICATIONS

Power supply	1x 3 V CR2032 battery (included)
Battery life	up to 2 years
Ambient temperature	-20 °C to 40 °C
Humidity	30 % to 70 % RH
Multi-click support	Up to 4 possible actions
Encryption	AES encryption (CCM mode)
Beacon mode	Yes
Shell material	Plastic
Color	White, black, red, blue
Operational range (depending on local conditions)	<ul style="list-style-type: none">• Up to 10 m / 33 ft indoors• Up to 30 m / 100 ft outdoors
Dimensions (HxWxD)	36x36x6 mm / 1.44x1.44x0.25 in
Weight with the battery	9 g

YOUR KEY TO EFFORTLESS SCENE CONTROL

easily set your push sequence and create different scenes with a set of actions. Use the Shelly Smart Control app to create a “Movie Night” scene that sets your connected RGBW2 light strips to a dim blue color and brings the blinds down.



Shelly ^{BLU} Wall Switch 4

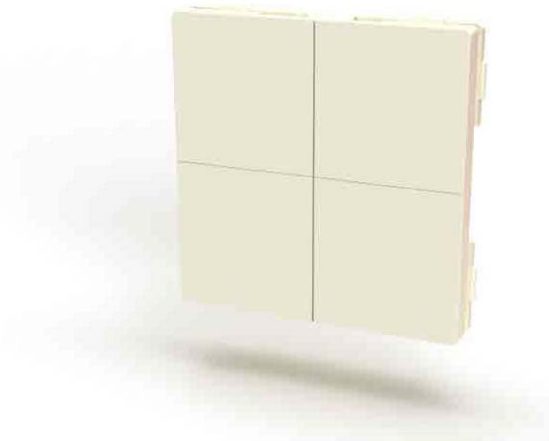

PORTABLE CONTROL

When used standalone, it lets you freely manage your home's lighting, appliances, and scenes from anywhere within range. Configure the four buttons to handle tasks like turning off upstairs lights from your downstairs couch, adjusting thermostat settings without leaving your bed. Shelly BLU Wall Switch 4 puts convenience in your hands, making it easy to adapt your surroundings to any activity.



SET THE PERFECT BRIGHTNESS AND POSITION

Shelly BLU Wall Switch 4 gives you precise control over your curtains, blinds, shutters, and dimming lights. Adjust your curtains through the customizable button presses that can set their exact position. Similarly, the dimming feature allows you to tailor brightness to match any activity and create the ideal ambiance every time.



Bluetooth-operated

Quicker response and easy inclusion.



Multi-click action trigger

Execute up to 16 pre-set actions or scenes with simple click combinations.



Long battery life

Experience uninterrupted performance with an extended battery life lasting up to 2 years.



No wiring needed

Mount seamlessly with Shelly, Legrand, Gira, Merten & Busch-Jaeger wall frames.

GIRA, MERTEN



BUSCH-JAEGER



SMART CONTROL MADE SIMPLE

Whether mounted on the wall* or used standalone, **Shelly BLU Wall Switch 4** adapts to your lifestyle. Equip your home with the ability to perform up to 16 different actions using simple click combinations. From turning lights on and off to activating appliances or custom scenes, control is always at your fingertips. It's designed to fit seamlessly with wall frames from leading brands like Shelly, Legrand, Gira, Merten, and Busch-Jaeger, ensuring it complements any room's decor.

*Wall mounting requires a Shelly Wall Switch Adapter.

TECHNICAL SPECIFICATIONS

Power supply	1x 3 V CR2032 battery (included)
Battery life	up to 2 years
Ambient temperature	-20 °C to 40 °C
Humidity	30 % to 70 % RH
Multi-click support	Up to 16 possible actions
Encryption	AES encryption (CCM mode)
Beacon mode	Yes
Shell material	Plastic
Color	White
Operational range (depending on local conditions)	<ul style="list-style-type: none">• Up to 10 m / 33 ft indoors• Up to 30 m / 100 ft outdoors
Dimensions (HxWxD)	46x46x13 mm / 1.81x1.81x0.51 in
Weight with the battery	17 g / 0.6 oz

ONE SWITCH, MANY USES

Replace your ordinary switches with Shelly BLU Wall Switch 4! Easily mountable, on any wall, without any wiring, Shelly BLU Wall Switch 4 lets you manage lighting, appliances and activate scenes from one place. Configure the four customizable buttons to perform up to 16 actions - turn appliances on and off, adjust dimming, or activate scenes. For example, you could use it to shut down all non-essential devices when leaving home with just 1 button press.

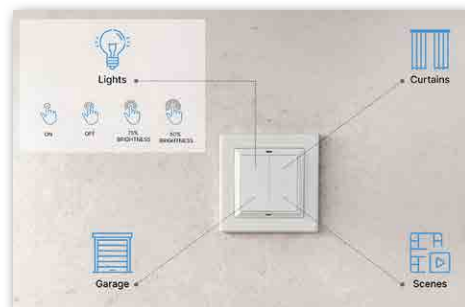

SHELLY, LEGRAND



Shelly^{BLU} Door/Window



Invisible Protection

Designed to seamlessly blend into your home's aesthetics, this is the first Bluetooth sensor that can be discreetly placed inside the frame of your windows, remaining completely invisible to the eye.



Bluetooth operated

Quicker response, longer battery life and easy inclusion



Immediate response

The sensor has a reaction time of less than 100ms



Long-lasting battery

Battery life of up to 5 years, depending on daily usage



Integrated sensors

Shelly BLU Door/Window has integrated LUX and tilt measurement sensors



Scripting

Use the scripting functionalities on your Shelly Plus and Pro devices to create complex automations



Scene activation

Set custom scenes by combining Shelly BLU Door/Window with your other Shelly devices

WHY SHELLY BLU DOOR/WINDOW? SMART SECURITY STARTS AT YOUR DOOR!

Shelly BLU Gateway is a smart BLE to Wi-Fi gateway in a USB A dongle.

TECHNICAL SPECIFICATIONS

Power supply	1x 3 V CR2032 battery (included)
Battery life	5 years
Ambient temperature	-20°C to 40°C / -5°F to 105°F
Humidity	30 % to 70 % RH
Multi-click support	Up to 4 possible actions
Encryption	AES encryption (CCM mode)
Beacon mode	Yes
Shell material	Plastic
Color	white, black, brown
Operational range (depending on local conditions)	<ul style="list-style-type: none">• Up to 10 m / 33 ft indoors• Up to 30 m / 100 ft outdoors
Dimensions (HxWxD)	35x35x7 mm / 1.38x1.38x0.27 in (Sensor unit) 35x12x7 mm / 1.44x0.47x0.27 in (Magnet)
Weight with the battery	10 g / 0.35 oz (Device with the battery) 8 g / 0.28 oz (Magnet)
Reed switch	Yes
G-sensor	Yes
Light sensor	Yes

PROTECT YOUR HOME, EVEN WHEN YOU'RE AWAY

Place Shelly BLU Door/Window on your front door, balconies, windows, or garage door, and receive a notification if someone opens them while you are away. This sensor can be used as part of your security system using automation scenarios or scenes.

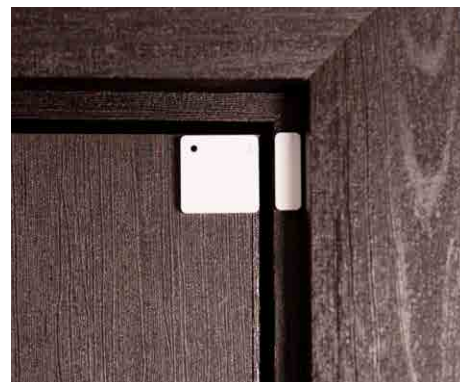

LET NO ENERGY GO TO WASTE

Shelly BLU Door/Window can also contribute to your energy efficiency efforts. By connecting it to other devices, you can automate the adjustment of heating, cooling, or lighting based on the door or window open state. For example, when a window is opened, the system can automatically turn off the heating to conserve energy.

Shelly^{BLU} Motion



MONITOR YOUR HOME FROM ANYWHERE

Shelly BLU Motion provides the perfect solution to safeguard your living space. This small form factor sensor can fit multiple spaces, with a 5 year of battery prolonged life. You can set up custom alarm zones, defining specific regions where motion detection is critical. This enables the sensor to instantly alert you on your phone the moment any unauthorized movement is detected. With its smart sensitivity adjustment, Shelly BLU Motion allows you to customize the sensor's response to distinguish between pet movements and potential threats. With 256 levels of sensitivity, you can fine-tune the sensor, preventing false alarms and ensuring accurate detection of relevant motion events.



Bluetooth operated

Quicker response, longer battery life and easy inclusion



Immediate response

The sensor has a reaction time of less than 100 ms



Long-lasting battery

Battery life of up to 5 years, depending on daily usage



Scripting

Use the scripting functionalities on your Shelly Plus and Pro devices to create complex automations



Scene activation

Set custom scenes by combining Shelly BLU Motion with your other Shelly devices



WHY SHELLY BLU MOTION?

SMART SECURITY STARTS AT YOUR DOOR!

Shelly BLU Motion is a smart Bluetooth motion detection sensor featuring a lux meter. The device comes ready-to-use with a battery installed. Connect all your Bluetooth devices with the cloud to create a smart ecosystem!

TECHNICAL SPECIFICATIONS

Power supply	1x 3 V CR2477 battery (included)
Battery life	5 years
Ambient temperature	-20°C to 40°C / -5°F to 105°F
Humidity	30 % to 70 % RH
Beacon mode	Yes
Shell material	Plastic
Color	white
Operational range (depending on local conditions)	<ul style="list-style-type: none">• Up to 10 m / 33 ft indoors• Up to 30 m / 100 ft outdoors
Dimensions (HxWxD)	32x42x27 mm / 1.26x1.65x1.06 in
Weight with the battery	26 g / 0.92 oz (Device with the battery)
Radio protocol	Bluetooth
Frequency	2400 - 2495 MHz
Max. RF power	4 dBm
Encryption	AES encryption (CCM mode)

CREATE YOUR HOME SCENARIOS

Integrating Shelly BLU Motion with other devices unlocks the full potential of your smart home automation. As you come home, Shelly BLU Motion detects your presence and immediately turns the lights on, offering you a warm welcome home. This also enhances energy efficiency, as lights only activate when needed. Adjust their working duration, create lighting scenes for different times of the day, or incorporate color-changing bulbs to set the perfect ambiance.



Shelly^{BLU} Gateway



UNITE YOUR SMART DEVICES

Shelly BLU Gateway is a small form factor USB dongle acting as the gateway between Shelly BLU devices and the Shelly Cloud. If you want to extend your existing smart ecosystem of Shelly Gen-1 devices, that do not feature Bluetooth connectivity, with Shelly BLU sensors, Shelly BLU Gateway can serve as a gateway to Shelly Cloud and thus to your existing Gen-1 devices. This way, you can eliminate the need for an upgrade to Shelly Plus or Pro device.

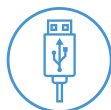

USB Type-A Plug



Wi-Fi, Bluetooth connectivity

Quicker response and easy inclusion



Embedded web interface



Scripting

Use the scripting functionalities on your Shelly Plus and Pro devices to create complex automations



Scene activation

Set custom scenes by combining Shelly BLU Gateway with your other Shelly devices

WHY SHELLY BLU GATEWAY?

Shelly BLU Gateway is a smart BLE to Wi-Fi gateway in a USB A dongle.

TECHNICAL SPECIFICATIONS

Power supply	5 VDC (from USB Type-A port)
Ambient temperature	-20 °C to 40 °C
Humidity	30 % to 70 % RH
Beacon mode	Yes
Shell material	Plastic
Color	white
Operational range Bluetooth (depending on local conditions)	<ul style="list-style-type: none">• Up to 20 m / 66 ft indoors• Up to 30 m / 100 ft outdoors
Operational range Wi-Fi (depending on local conditions)	<ul style="list-style-type: none">• Up to 30 m / 100 ft indoors• Up to 50 m / 160 ft outdoors
Dimensions (HxWxD)	45x20x8 mm / 1.77x0.79x0.21 in
Weight with the battery	Device with the battery - 5g / 0.18 oz
Bluetooth protocol	4.2
Frequency	2400 - 2495 MHz

EXPAND YOUR SMART ECOSYSTEM

When you need to ensure smooth data transfer from your bluetooth-enabled devices to a wide array of home automation platforms, Shelly BLU Gateway provides a reliable, effective path for communication through MQTT protocol. Thus, you can expand your current smart ecosystem with branded devices and platforms of your choice.





WAVE LINE WORKS ON Z-WAVE®

Shelly Qubino Wave line of devices operates on Z-Wave® wireless communication technology, which is one of the most popular standardized technologies for smart homes in the world. All Wave devices work on the latest Z-Wave® chip generation S800, providing lower power consumption, higher network reliability, and increased network range.

COMPATIBLE WITH ANY Z-WAVE® GATEWAY

Wave devices can be remotely controlled and monitored through Z-Wave® network using a gateway/hub. You can use them with any certified Z-Wave® gateway, as all Z-Wave® smart home products can communicate with each other, regardless of their brand or manufacturer.

EASY INSTALLATION AND AUTOMATIC SET-UP

All devices provide quick and easy installation with automatic setup for maximum convenience. Once installed and powered on, the device will be automatically added to your Z-Wave® gateway/hub and network. This will enable you to control and monitor connected appliances from anywhere, using a smart home app on your smartphone/tablet, or to set automation actions, scenes, schedules, etc.

WAVE LINE FEATURES



High compatibility

Compatible with all certified Z-Wave® devices and gateways available in the market (over 4000).



Ultra-low power consumption

Most Wave devices operate at less than 0.3 W.



Bulletproof security

Security 2 ensures secure communication with advanced encryption (AES128) and authentication, offering the highest level of network security.



High reliability

Wave devices operate on a sub-GHz frequency, ensuring stable and reliable wireless connection without interference.

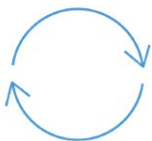

Automatic set-up

SmartStart for automatic and hassle-free inclusion to your Z-Wave network.



Extended wireless range

Up to 40 m indoor range (depending on obstacles).



Z-Wave signal repeater

Devices act as Z-Wave® signal repeaters, extending the Z-Wave® network range.



OTA firmware updates

Support over-the air updates for the convenient installation of new firmware versions.

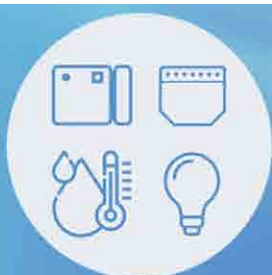

Z-Wave Device



Z-Wave Gateway

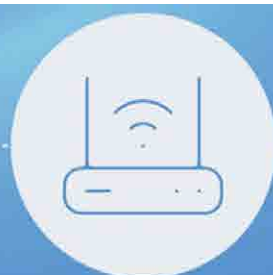

Router



Smartphone

Shelly Wave 1 Mini



SYNCHRONIZE YOUR LIGHTS WITH YOUR DAILY ROUTINE

With its compact size, Wave 1 Mini can fit behind any light switch or even within the ceiling rose of your lamp. Synchronize your lighting to sunset times to adjust to the changing daylight hour, ensuring your home is always pleasantly illuminated and welcoming, when the house is occupied. Additionally, you can automate lights to turn off after you family's bedtime, preventing lights being on all night and avoid unnecessary energy consumption.



CONTROL YOUR GARAGE DOOR REMOTELY

Wave 1 Mini's compact design allows for flexible placement options, enabling you to install it directly within the garage door opener's housing or even near the motor. Its 8 A power handling capability ensures reliable garage door control, allowing you to conveniently operate your garage door remotely without the need for bulky external modules.



Z-Wave® operated

Include Wave 1 Mini to your Z-Wave network and control it remotely. It's compatible with all certified Z-Wave gateways.



Dry Contacts

Connect different power supply loads (up to 8 A) to the device.



Associations

Establish direct communication between devices in your Z-Wave local network and set custom actions with no hub present!



Wide range of voltage support

Use a wide range of output voltage levels. Supports low voltages.



Smart Schedules

Create personalized schedules aligned with your daily routine or synchronize with sunrise/sunset to manage your lighting (gateway required).



Smart Scenes

Set custom scenes by combining Wave 1 Mini with any other Z-Wave devices (gateway required).



MAKE ANY SMALL ELECTRICAL APPLIANCE IN YOUR HOME SMART

Transform any electrical appliance in your home, whether old or new, into smart device with Wave 1 Mini. Its 8 A limit is perfect for small to medium-sized appliances, such as lamps, electric water kettles, and others. Place it in the socket or fit it discreetly inside the appliance's casing, avoiding the need for additional external wiring.

SIZE DOES MATTER!

Wave Mini devices open a world of possibilities, allowing you to seamlessly integrate them into even the most tightly packed spaces and switch boxes. Thanks to their reduced size, Wave Mini devices fit effortlessly into all kinds of electrical boxes, including Danish wall boxes. Furthermore, they can be discreetly installed directly within the appliance you want to control or monitor.

TECHNICAL SPECIFICATIONS

Power supply	110 - 240 V AC, 50/60 Hz
Power consumption	< 0.3 W
Max. switching voltage AC	240 V
Max. switching current AC	8 A
Max. switching voltage DC	30 V
Max. switching current DC	5 A
Overheating protection	Yes
Distance	Up to 40 m / 131 ft indoors (depends on local condition)
Z-Wave® repeater	Yes
CPU	Z-Wave® S800
Z-Wave® frequency bands	868,4 MHz
Maximum radio frequency power transmitted in frequency band	< 25 mW
Dimensions (HxWxD)	29x35x16 mm / 1.11x1.35x0.63 in
Ambient temperature	-20°C to 40°C / -5°F to 105°F
Mounting	Wall box

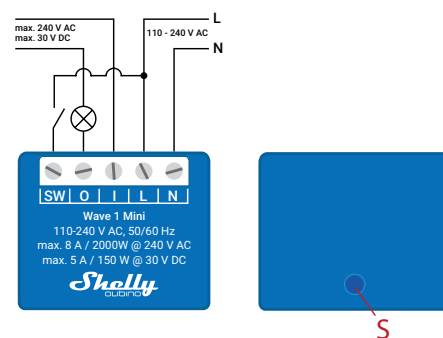

LEGEND

Device terminals:

- **N:** Neutral terminal
- **L:** Live terminal (110–240 V AC)
- **SW (SW1):** Switch/push-button input terminal (controlling O(O1))
- **I:** Load circuit input terminal
- **O (O1):** Load circuit output terminal (1)

Wires:

- **N:** Neutral wire
- **L:** Live wire (110-240 V AC)

Button:

- **S:** S button



Shelly Wave 1PM Mini



STAY ON TOP OF YOUR POWER CONSUMPTION AND SAVE MONEY

With Wave 1PM Mini's integrated precise power metering, you can easily track and control the consumption of your smaller electrical appliances, such as personal electronics, fans, lighting fixtures, and kitchen appliances. Making it easier on you and your wallet.



MAKE ANY APPLIANCE IN YOUR HOME SMART

Transform any electrical appliance in your home, whether old or new, into a smart device with Wave 1PM Mini. Its 8 A limit is perfect for small to medium-sized appliances, such as lamps, kitchen appliances, and others. It provides precise power monitoring, allowing you to track energy consumption in real-time, and gives you remote control over appliances, no matter where you are. Place it in the socket or fit it discreetly inside the appliance's casing, avoiding the need for additional external wiring.



Z-Wave® operated

Include Wave 1PM Mini to your Z-Wave network and control it remotely. It's compatible with all certified Z-Wave gateways.



Associations

Establish direct communication between devices in your Z-Wave local network and set custom actions with no hub present!



Power monitoring

Wave 1PM Mini provides precise power consumption monitoring.



Wide range of voltage support

Use a wide range of output voltage levels.



Smart Schedules

Create personalized schedules aligned with your daily routine or synchronize with sunrise/sunset to manage your lighting (gateway required).



Smart Scenes

Set custom scenes by combining Wave 1PM Mini with any other Z-Wave devices (gateway required).



CREATE A COSY MOVIE NIGHT ATMOSPHERE WITH SMART SCENES

Combine Wave 1PM Mini with other devices and create custom scenes based on time, lighting, or various triggers. With the „Movie Night“ scene, you can prepare your home for a cosy movie night with your friends and family. With only one tap on your smartphone you can customise the lighting, close the curtains, and adjust the temperature for that extra cosy feeling.

MINI SIZE, MINI PRICE

Designed with convenience in mind, this mini switch has all the capabilities of the Wave 1PM fit into a compact and space-saving form factor. With its size reduced by 35% of the Wave 1PM device, the **Shelly Wave 1PM Mini** is perfect for those tight spaces where traditional modules simply won't fit. Despite their small size, the Wave Mini devices don't compromise on performance or functionality.

TECHNICAL SPECIFICATIONS

Power supply	110 - 240 V AC, 50/60 Hz
Power consumption	< 0.3 W
Power measurement	Yes
Max. switching voltage AC	240 V
Max. switching current AC	8 A
Max. switching power AC	2000 W
Overheating protection	Yes
Distance	Up to 40 m / 131 ft indoors (depends on local condition)
Z-Wave® repeater	Yes
CPU	Z-Wave® S800
Z-Wave® frequency bands	868,4 MHz
Maximum radio frequency power transmitted in frequency band	< 25 mW
Dimensions (HxWxD)	29x35x16 mm / 1.11x1.35x0.63 in
Ambient temperature	-20°C to 40°C / -5°F to 105°F
Mounting	Wall box

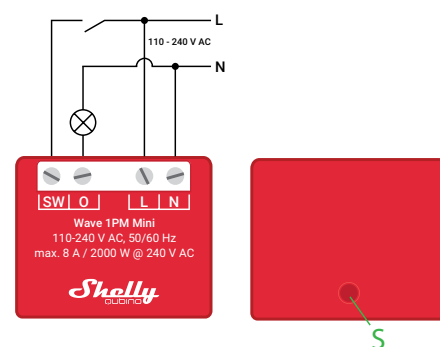

LEGEND

Device terminals:

- **N:** Neutral terminal
- **L:** Live terminal (110–240 V AC)
- **SW (SW1):** Switch/push-button input terminal (controlling O(O1))
- **O (O1):** Load circuit output terminal (1)

Wires:

- **N:** Neutral wire
- **L:** Live wire (110-240 V AC)

Button:

- **S:** S button

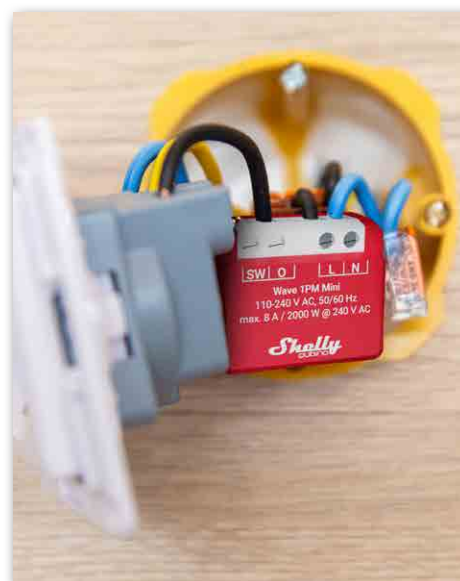

Shelly Wave PM Mini



PREVENTATIVE MANAGEMENT

When an electrical appliance is damaged, it doesn't simply stop working. Usually, it increases the amount of energy used to compensate for its operational capacity. Since there is no visible difference in its performance, it might take months before you can identify a problem, leading to inefficiency and wasted energy. Wave PM Mini, however, will immediately report the increase in energy consumption and will save you additional expenses on repairs or replacement of equipment.

TRACK YOUR POWER CONSUMPTION AND ENHANCE COST-EFFECTIVENESS

It can happen sometimes that we forget to switch off all the lights or leave an appliance we don't need during the night on, which generates unnecessary energy. Wave PM Mini's power monitoring enables the detection and eradication of excess energy consumption across your household. Together with smart scenes, you can use Wave PM Mini's data to set off scenarios, such as turning off appliances during a spike to protect them or during the night to save energy.



Z-Wave® operated

Include Wave PM Mini to your Z-Wave network and control it remotely. It's compatible with all certified Z-Wave gateways.



Supports up to 16 A

The device can measure power consumption of a load of up to 16 A.



Power monitoring

Wave PM Mini provides precise power consumption monitoring.



Wide range of voltage support

Use it to monitor a wide range of AC devices and appliances.



Associations

Establish direct communication between devices in your Z-Wave local network and set actions with no gateway present!



Smart Scenes

Set custom scenes by combining Wave PM Mini with any other Z-Wave devices (gateway required).

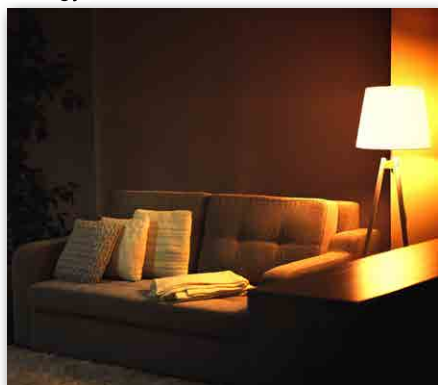

MINI SIZE, MINI PRICE

Designed with convenience in mind, this Mini power meter has the powerful capability of energy consumption monitoring fit into a compact and space-saving form factor. **Shelly Wave PM Mini** is perfect for those tight spaces where traditional devices simply won't fit. Despite their small size, the Wave Mini devices don't compromise on performance or functionality.

TECHNICAL SPECIFICATIONS

Power supply	110 - 240 V AC, 50/60 Hz
Power consumption	< 0.3 W
Power measurement	Yes
Max. measurement power	3840 W
Max. measurement current	16 A
Overheating protection	Yes
Distance	Up to 40 m / 131 ft indoors (depends on local condition)
Z-Wave® repeater	Yes
CPU	Z-Wave® S800
Z-Wave® frequency bands	868,4 MHz
Maximum radio frequency power transmitted in frequency band	< 25 mW
Dimensions (HxWxD)	29x35x16 mm / 1.11x1.35x0.63 in
Ambient temperature	-20°C to 40°C / -5°F to 105°F
Mounting	Wall box

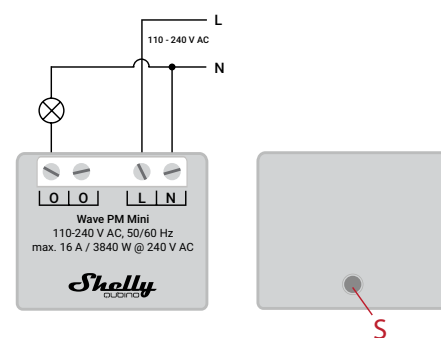

LEGEND

Device terminals:

- **N:** Neutral terminal
- **L:** Live terminal (110–240 V AC)
- **O:** Load circuit output terminal (bridged internally)

Wires:

- **N:** Neutral wire
- **L:** Live wire (110-240 V AC)

Button:

- **S:** S button

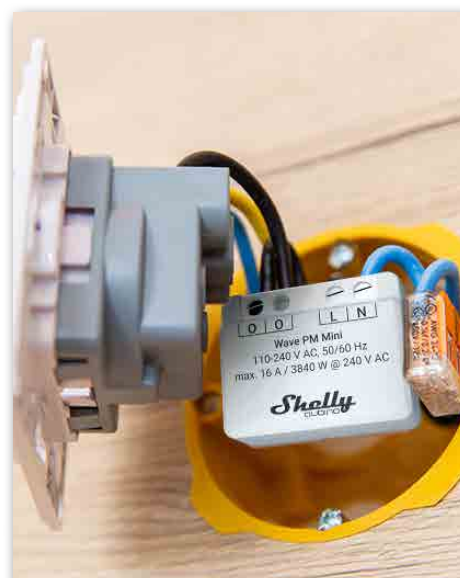

Shelly Wave 1



Available EU and ANZ versions

AUTOMATE YOUR IRRIGATION SYSTEM FOR EFFORTLESS GARDENING

Keeping your garden green with a busy lifestyle can be challenging, but with an automated irrigation system, you can effortlessly manage your garden's watering needs with a tap on your smartphone.

CONTROL YOUR GARAGE DOOR REMOTELY

Have you closed the garage door after leaving your home? From now on, simply make sure by checking on your smartphone. Wave 1 has operational voltages of 12 V DC and 24-48 V DC, which make it perfect for garage door control. (only for EU)

SET UP ASSOCIATIONS AND LET YOUR HOME WELCOME YOU

Configure Wave 1 and other devices in your Z-Wave network and create associations between them for direct communication without a gateway. Automate your door lock and lights and set a rule: whenever the front door is unlocked, the lobby/hallway lights turn on.



Z-Wave® operated

Connect Wave 1 to your Z-Wave network and control it remotely. It's compatible with all certified Z-Wave gateway



Associations

Establish direct communication between devices in your Z-Wave local network and set custom actions with no hub present



Dry contact

Connect different power supply loads (up to 16 A) to the device



Wide range of voltage support

Use a wide range of output voltage levels. Supports low voltages



Smart schedules

Create personalized schedules aligned with your daily routine or synchronize with sunrise/sunset to manage your lighting (gateway required)



Smart scenes

Set custom scenes by combining Wave 1 with any other Z-wave devices (gateway required)

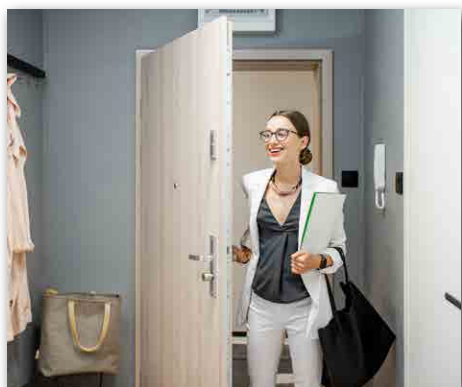

WHY SHELLY QUBINO WAVE 1?

Control a wide range of devices and office equipment, such as electrical locks, gates, garage doors, irrigation systems, LED strips, lights, and sockets, from anywhere. The output contact is voltage-free (dry contact), allowing you to connect various power supply loads of up to 16 A to the device.

TECHNICAL SPECIFICATIONS

Power supply	110-240 VAC, 50/60 Hz (for EU and ANZ) 24-48 VDC / 12 VDC ± 10% (only for EU)
Power consumption	< 0.3 W
Max. switching voltage AC	240 V
Max. switching current AC	16 A
Max. switching voltage DC	30 V (only for EU)
Max. switching current DC	10 A (only for EU)
Overheating protection	Yes
Distance	Up to 40 m / 131 ft indoors (depends on local condition)
Z-Wave® repeater	Yes
CPU	Z-Wave® S800
Z-Wave® frequency bands	868,4 MHz for EU / 919,8 MHz for ANZ
Maximum radio frequency power transmitted in frequency band	< 25 mW
Dimensions (HxWxD)	37x42x16 mm / 1.46x1.65x0.63 in
Ambient temperature	-20°C to 40°C / -5°F to 105°F
Mounting	Wall box

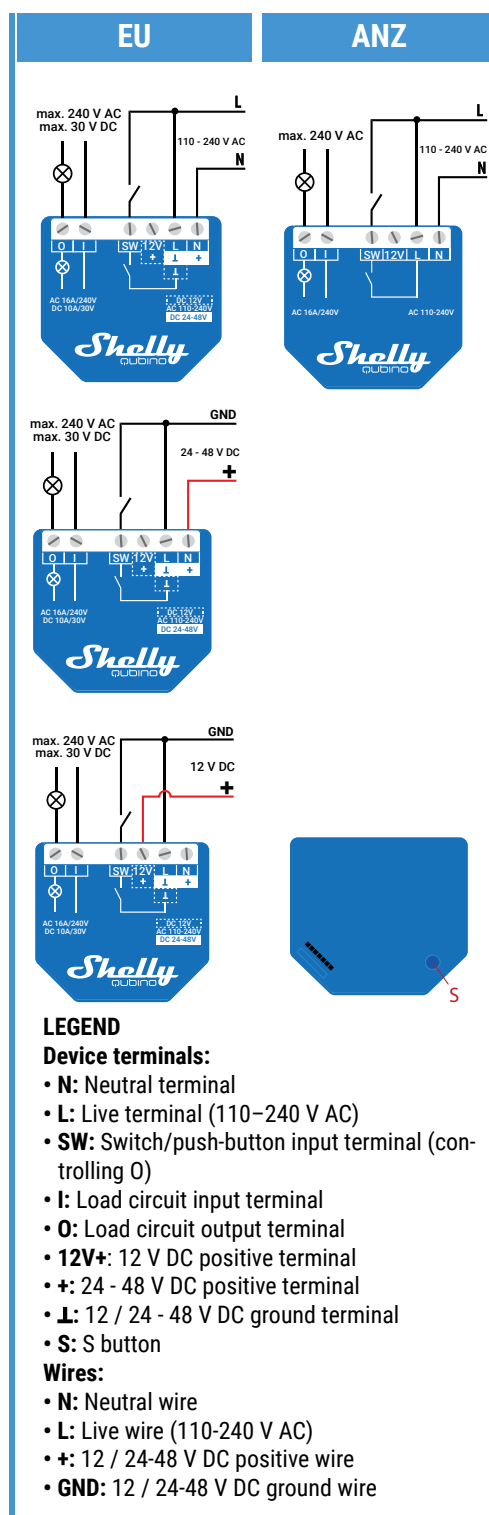

Shelly Wave 1PM

Available EU and ANZ versions

AUTOMATE AND CONTROL YOUR ELECTRICAL APPLIANCES FROM ANYWHERE

Easily automate and remotely control a wide range of appliances in your home, including water heaters, heating devices and. Imagine waking up to a cozy home on a chilly morning, as your heating appliances automatically activate before you even step out of bed.

CONTROL YOUR POOL SYSTEM REMOTELY

Automate your pool system and enjoy fresh, clean water all summer long. Shelly Wave 1PM enables you to easily schedule and monitor the operation of pool equipment. Set up routines to automatically run the pool pump and filtration system, optimizing water circulation and maintaining water clarity. Schedule your pool lights to turn on automatically as the daylight fades and dive into a more efficient and enjoyable experience!

MAXIMIZE THE COMFORT OF YOUR HOME WITH SMART SCENES

Combine Wave 1PM with other devices and create custom scenes based on time, lighting, or various triggers. With a "Good Night" scene, you can conveniently prepare your home for a peaceful night's sleep without leaving your bed. Turn off lights, media devices, lock doors, and adjust heating, all with a simple voice command or a single tap on your smartphone.



GMA-517538



Z-Wave® operated

Connect Wave 1PM to your Z-Wave network and control it remotely. It's compatible with all certified Z-Wave gateways.



Associations

Establish direct communication between devices in your Z-Wave local network and set custom actions with no hub present!



Power Monitoring

Wave 1PM provides precise power consumption monitoring.



Wide range of voltage support

Use a wide range of output voltage levels.



Smart schedules

Create personalized schedules aligned with your daily routine or synchronize with sunrise/sunset to manage your lighting (gateway required).



Smart scenes

Set custom scenes by combining Wave 1PM with any other Z-wave devices (gateway required).



WHY SHELLY QUBINO WAVE 1PM?

Control and measure power consumption for a wide range of home appliances and office equipment (lights, power lines, security systems, heaters, water heaters, etc.) from anywhere.

TECHNICAL SPECIFICATIONS

Power supply	110-240 VAC (for EU and ANZ) 24-30 VDC (only for EU)
Power consumption	< 0.3 W
Power measurement (W)	Yes
Max. switching voltage AC	240 V
Max. switching voltage DC	30 V (only for EU)
Max. switching current AC	16 A
Max. switching current DC	10 A (only for EU)
Overheating protection	Yes
Distance	Up to 40 m / 131 ft indoors (depends on local condition)
Z-Wave® repeater	Yes
CPU	Z-Wave® S800
Z-Wave® frequency band	868,4 MHz for EU / 919,8 MHz for ANZ
Maximum radio frequency power transmitted in frequency band	< 25 mW
Dimensions (HxWxD)	37x42x16 mm / 1.46x1.65x0.63 in
Ambient temperature	-20°C to 40°C / -5°F to 105°F
Mounting	Wall box

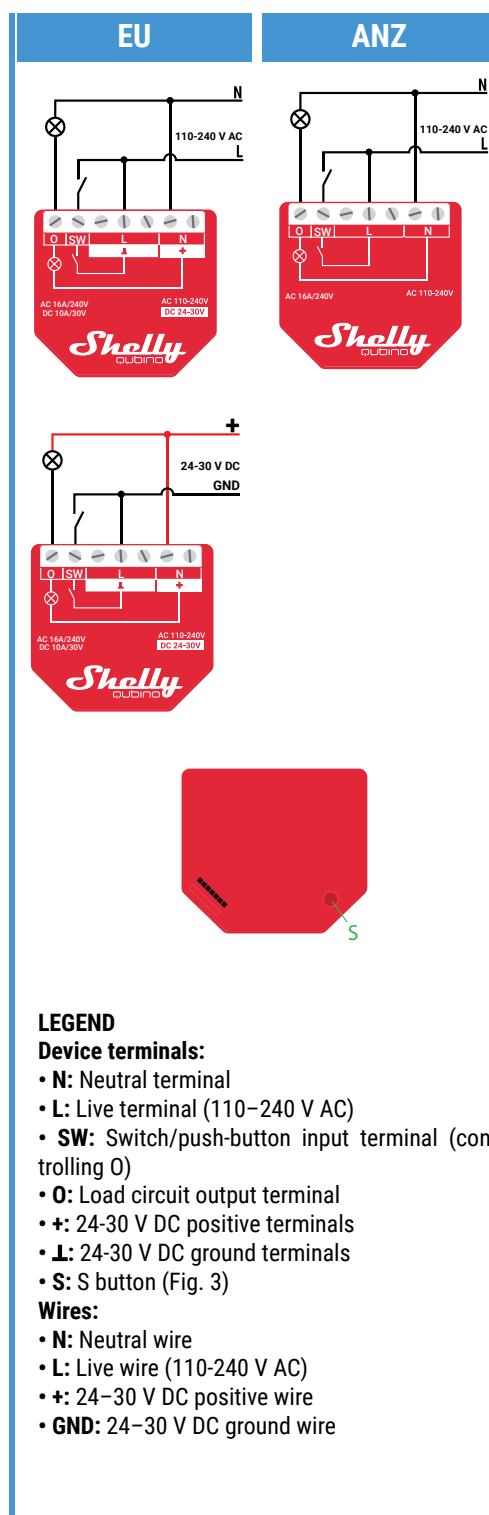

Shelly Wave 2PM

Available EU and ANZ versions

CONTROL TWO LIGHTS WITH A SINGLE DEVICE

Wave 2PM allows you to remotely control two lights or other electrical appliances and monitor their energy usage. Use the manual switch, smart home app, home automation system or voice control. Easy, convenient, and energy-efficient!

TRACK YOUR ENERGY USAGE AND SAVE MONEY

With Wave 2PM you can precisely measure power consumption for each channel separately (W) and together (W, kWh). Keep an eye on real-time consumption for the connected devices and adjust usage patterns to cut utility costs with ease!

CREATE SCHEDULES THAT FOLLOW YOUR DAILY ROUTINE

Enhance the energy efficiency of your home and simplify your daily life. Set your lights to turn on gradually every morning at 7 am or at sunset, if the house is occupied. This way, your home can automatically follow your daily routine and create an atmosphere that suits you at a particular moment of the day.



Z-Wave® operated

Connect Wave 2PM to your Z-Wave network and control it remotely. It's compatible with all certified Z-Wave gateways.



Associations

Establish direct communication between devices in your Z-Wave local network and set custom actions with no hub present!



Power Monitoring

Wave 2PM provides precise power consumption monitoring on each channel separately and in total.



Wide range of voltage support

Use it to control a wide range of devices and appliances.



Smart schedules

Create personalized schedules aligned with your daily routine or synchronize with sunrise/sunset to manage your lighting (gateway required).



Smart scenes

Set custom scenes by combining Wave 2PM with any other Z-Wave devices (gateway required).



WHY SHELLY QUBINO WAVE 2PM?

With a single **Shelly Wave 2PM** device you can remotely control two independent electrical appliances and monitor their power consumption separately or together. Manage your devices from anywhere with your smartphone/tablet, or simply set up schedules or scenes that follow your daily routine for maximum efficiency and comfort.

TECHNICAL SPECIFICATIONS

Power supply	110-240 VAC (for EU and ANZ) 24 VDC (only for EU)
Power consumption	< 0.3 W
Power measurement (W)	Yes
Max. switching voltage AC	240 V
Max. switching voltage DC	30 V (only for EU)
Max. switching current AC	10 A per channel, 16 A total, 18 A total peak
Max. switching current DC	10 A (only for EU)
Overheating protection	Yes
Distance	Up to 40 m / 131 ft indoors (depends on local condition)
Z-Wave® repeater	Yes
CPU	Z-Wave® S800
Z-Wave® frequency band	868,4 MHz for EU / 919,8 MHz for ANZ
Maximum radio frequency power transmitted in frequency band	< 25 mW
Dimensions (HxWxD)	37x42x16 mm / 1.46x1.65x0.63 in
Ambient temperature	-20°C to 40°C / -5°F to 105°F
Mounting	Wall box

Wires:

- **N:** Neutral wire
- **L:** Live wire (110-240 V AC)
- **+**: 24 V DC positive wire
- **GND:** 24 V DC ground wire

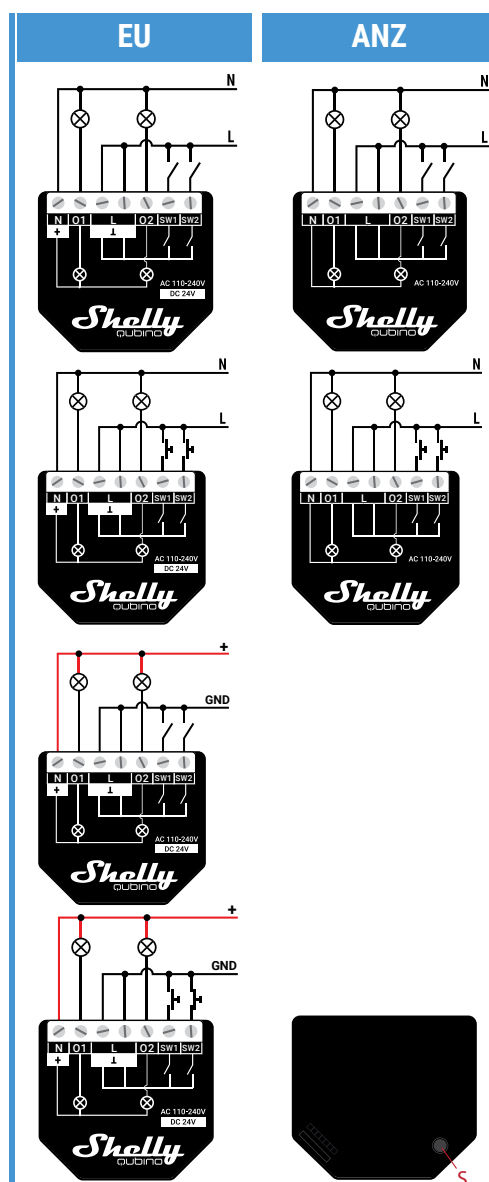

LEGEND

Device terminals:

- **N:** Neutral terminal
- **L:** Live terminals (110–240 V AC)
- **O1:** Load circuit 1 output terminal
- **O2:** Load circuit 2 output terminal
- **SW1:** Switch/push-button input terminal (controlling O1)
- **SW2:** Switch/push-button input terminal (controlling O2)
- **+**: 24 V DC positive terminal
- **⊥:** 24 V DC ground terminals
- **S:** Z-Wave button

Shelly Wave Shutter

QUBINO

Available EU and ANZ versions



GMA-517539

CURTAINS THAT FOLLOW YOUR DAILY ROUTINE

Program your daily routines to perfection by synchronizing Wave Shutter with your regular morning and evening activities. Have your curtains open and close at your chosen hours every day, establishing an ideal ambience to start and end your day. Use position control to dictate your preferred curtain position, customizing your lighting levels to your exact liking. And don't worry—manual operation remains at your fingertips, with curtains being easily controllable via a switch or a push-button, suiting the needs of everyone in your home.



ADJUST THE AMOUNT OF NATURAL LIGHT FOR MAXIMUM COMFORT

Nowadays, many people prefer working from their home office. However, direct sunlight on your computer screen can be irritating. With Wave Shutter, you can adjust the position of the venetian blinds using your smart home app, without leaving your desk and interrupting your workflow. Additionally, it also allows you to adjust the blind slats angle, depending on how much natural light you prefer to let in. Make working from home as comfortable as possible to maximize productivity!



Z-Wave® operated

Connect Wave Shutter to your Z-Wave network and control it remotely. It's compatible with all certified Z-Wave gateways.



Position control

Set the desired position of your blinds, roller shutters, screens, awnings, and other devices powered by bi-directional AC motors.



Slats angle control

Use Wave Shutter with your venetian blinds and control the tilt position (angle) of slats to adjust the amount of light in a room.



Associations

Establish direct communication between devices in your Z-Wave local network and set custom actions with no hub present!



Smart Schedules

Set up your blinds to work automatically by creating personalized schedules aligned with your daily routine or synchronize with sunrise/sunset (gateway required).



Smart Scenes

Set custom scenes by combining Wave Shutter with any other Z-Wave devices (gateway required).

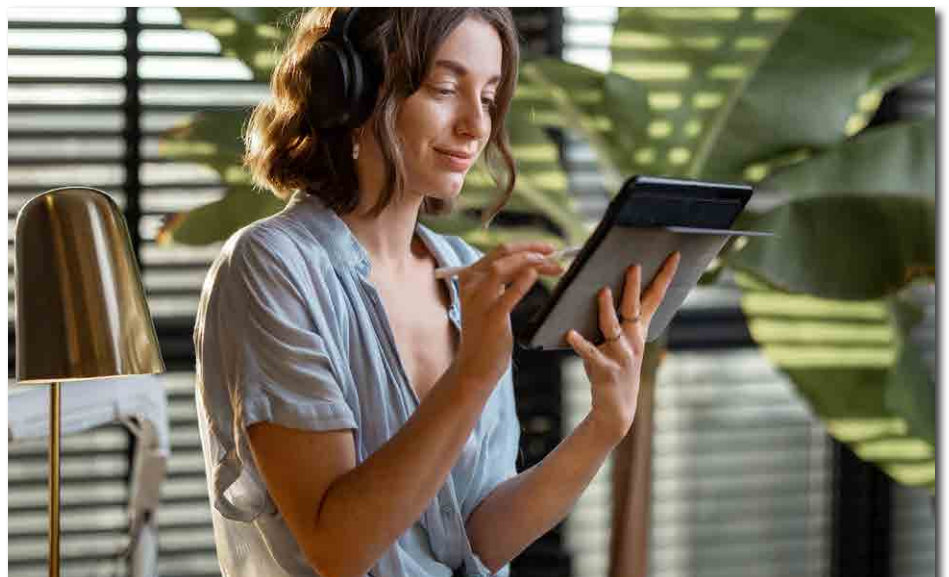

Z-WAVE™ SHUTTER CONTROL WITH POWER MEASUREMENT, 10 A PER CHANNEL

Set the desired position of your blinds, roller shutters, screens, awnings, and other devices powered by bi-directional AC motors from anywhere. In addition to controlling the position of the venetian blinds, Wave Shutter also allows you to adjust the angle of the slats. You can control it remotely using your smartphone or according to schedules or scenes, while retaining the option for manual operation with a switch.

TECHNICAL SPECIFICATIONS

Power Supply	110-240 VAC, 50/60 Hz
Power Consumption	< 0.3 W
Power measurement	Yes
Working temperature	-20°C to 40°C / -5°F to 105°F
Z-Wave® repeater	Yes
Max. switching voltage AC	240 V
Max. switching current AC	10 A per channel
Z-Wave® frequencies band	868,4 MHz for EU / 919,8 MHz for ANZ
Z-Wave® range	Up to 40 m / 131 ft indoors (depends on local condition)
Dimensions	37x42x16 mm / 1.46x1.65x0.63 in
CPU	Z-Wave® S800
Wire cross section range	0.5 to 1.5 mm ² / 20 to 16 AWG

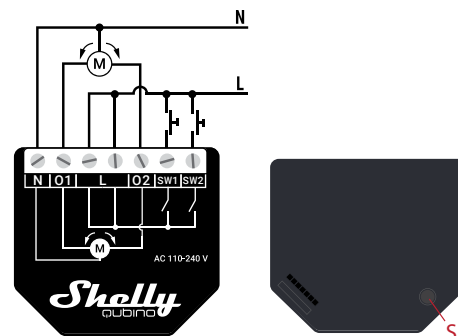

LEGEND

Device terminals:

- N:** Neutral terminal
- L:** Live terminals (110–240 VAC)
- O1:** Output terminal for motor UP (open)
- O2:** Output terminal for motor DOWN (close)
- SW1:** Input terminal for switch/push-button UP (open)
- SW2:** Input terminal for switch/push-button DOWN (close)

Wires:

- N:** Neutral wire
- L:** Live wire (110-240 VAC)

Button:

- S:** S button



Shelly Wave i4



MULTI-ACTIONS SUPPORT

With a simple push of a button, you can activate up to 12 scenes or actions from other Z-Wave devices in your network. Wave i4 supports up to 3 different automation actions per button, which makes it extremely convenient for quick manual control over a group of devices.

Install Wave i4 where it is the most convenient for you and set buttons to simultaneously control lights, blinds, and other devices in specific rooms or entire building.

Scene Activation:

1 click

Turn off multimedia appliances

2 clicks

Close blinds

1 long click (hold)

Turn on/off lights in the hall

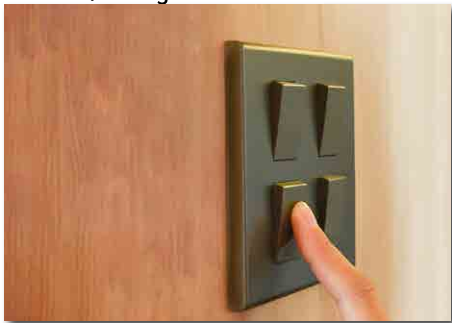

TRIGGER UP TO 8 ACTIONS WITHOUT A GATEWAY!

Wave i4 allows you to establish direct communication between your Z-Wave devices and set various associations without requiring a hub!* By supporting 2 associations per button, Wave i4 enables you to trigger and execute up to 8 actions and thus seamlessly control multiple Z-Wave devices with a simple press of a button



Z-Wave® operated

Include Wave i4 to your Z-Wave network and control it remotely. It's compatible with all certified Z-Wave gateways.



Multi-click support

Up to 12 possible actions. Control the lights, close the blinds, turn off outlets. Manually control any Z-Wave device in your network and run the scenes you desire.



Wide range of voltage support

Wave i4 can be powered by 110-240 V AC.



Associations

Establish direct communication between devices in your Z-Wave local network and set actions with no hub present! Configure up to 8 associations on the switch buttons and trigger them manually.



Smart Scenes

Set custom scenes by combining Wave i4 with any other Z-Wave devices (gateway required).



COMPLEX SCENES CONTROL

Manually activate or deactivate complex scenes. With Wave i4 you can run synchronized actions of several Z-Wave devices. You can install Wave i4 close to the front door of your home and turn off/on all the lights in your house with one push of the button, saving you time when you are in a hurry.

REPLACE ONE OF THE SWITCHES IN YOUR ROOM AND CONTROL ANY OTHER INSTALLED Z-WAVE DEVICE!

Shelly Wave i4 allows you to manually activate or deactivate any created scene, run synchronized actions, or execute complex trigger scenarios. You can use it to control other Z-Wave devices within your network with one push of a button. Due to its retrofit design, it is small enough to fit behind every wall switch. Wave i4 can show the status and control the action of four inputs, offering maximum convenience by enabling manual control of your smart home to all family members.

TECHNICAL SPECIFICATIONS

Power Supply	110-240 VAC, 50/60 Hz
Power Consumption	< 0.2 W
Power measurement	No
Working temperature	-20°C to 40°C / -5°F to 105°F
Z-Wave® repeater	Yes
Z-Wave® frequencies band	868,4 MHz
Z-Wave® range	Up to 40 m / 131 ft indoors (depends on local condition)
Dimensions	37x42x16 mm / 1.46x1.65x0.63 in
CPU	Z-Wave® S800
Wire cross section range	0.5 to 1.5 mm ² / 20 to 16 AWG

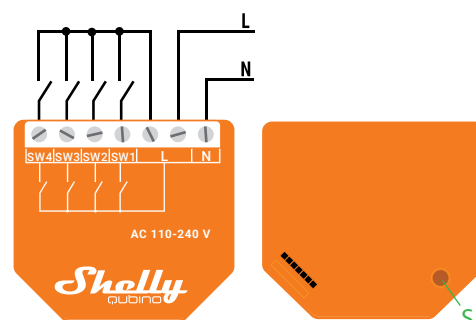

LEGEND

Device terminals:

N: Neutral terminal

L: Live terminals (110–240 V AC)

SW1: Switch/push-button input terminal

SW2: Switch/push-button input terminal

SW3: Switch/push-button input terminal

SW4: Switch/push-button input terminal

Wires:

N: Neutral wire

L: Live wire (110-240 V AC)

Button:

S: S button

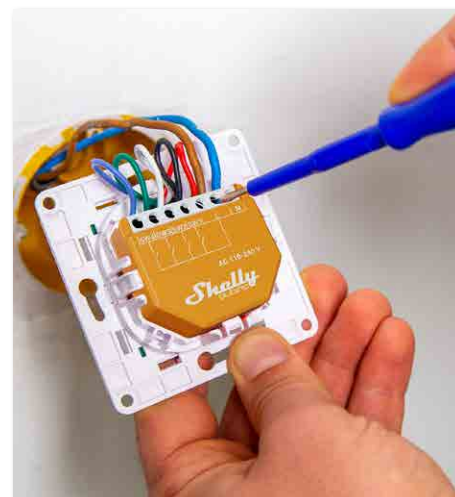

Shelly Wave i4DC



ULTIMATE COMFORT

One of the most frustrating things is to realize you forgot to switch off the lights in the living room before you go to bed. Especially when your phone is nowhere around. But there is no need to worry! Wave i4 DC allows manual control of other Z-Wave devices with a switch. Now the full control of your house is just one hand away!



PERFECT MATCH

Wave i4 DC is perfect for Shelly Wall Switch for Smart Relays – a 4 button switch. Each button can activate up to 4 different actions. That means that only one 4 button switch would allow as much as 16 scenes trigger and execution! Thanks to its compact dimensions and simple wiring, Shelly Wall Switch can fit into any existing switch console or even the tiniest spaces. No expansion of the wall space or any changes in the wiring needed!



Z-Wave® operated

Include Wave i4 DC to your Z-Wave network and control it remotely. It's compatible with all certified Z-Wave gateways.



Multi-click support

Up to 12 possible actions. Control the lights, close the blinds, turn off outlets. Manually control any Z-Wave device within your network and run the scenes you desire.



Wide range of voltage support

Wave i4 DC can be powered by 5-24 V



Associations

Establish direct communication between devices in your Z-Wave local network and set actions with no hub present! Configure up to 8 associations on the switch buttons and trigger them manually.



Smart Scenes

Set custom scenes by combining Wave i4 DC with any other Z-Wave devices (gateway required).



TRIGGER UP TO 8 ACTIONS WITHOUT A GATEWAY!

Wave i4 DC allows you to establish direct communication between your Z-Wave devices and set various associations without requiring a hub!* By supporting 2 associations per button, Wave i4 DC enables you to trigger and execute up to 8 actions and thus seamlessly control multiple Z-Wave devices with a simple press of a button.

Examples:

1 click (for basic commands)

Turn on/off lights

1 long click (hold) (for multilevel commands)

Dim lights or open/close blinds

*Gateway/hub is needed for a configuration of the device.

Z-WAVE™ 4-DIGITAL INPUTS CONTROLLER FOR ENHANCED ACTIONS CONTROL

Shelly Wave i4 DC is a 4-digital inputs controller that allows you to manually control other Z-Wave devices within your network. With a simple push of a button, you can activate up to 12 scenes or actions, which makes it extremely convenient for quick manual control over a group of appliances, such as lights, blinds, and other devices in specific rooms or entire building.

TECHNICAL SPECIFICATIONS

Power Supply	5 - 24 V DC
Power Consumption	< 0.3 W
Power measurement	No
Number of inputs	4
Working temperature	-20°C to 40°C / -5°F to 105°F
Z-Wave® repeater	Yes
Z-Wave® frequencies band	868,4 MHz
Z-Wave® range	Up to 40 m / 131 ft indoors (depends on local condition)
Dimensions	37x42x16 mm / 1.46x1.65x0.63 in
CPU	Z-Wave® S800
Wire cross section range	0.5 to 1.5 mm ² / 20 to 16 AWG

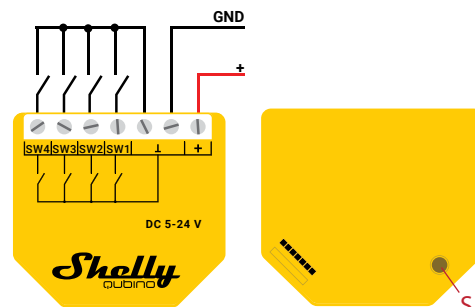

LEGEND

Device terminals:

⏏: Ground terminal

+: Positive terminal

SW1: Switch/push-button input terminal

SW2: Switch/push-button input terminal

SW3: Switch/push-button input terminal

SW4: Switch/push-button input terminal

Wires:

GND: Neutral wire

+: Positive wire

Button:

S: S button

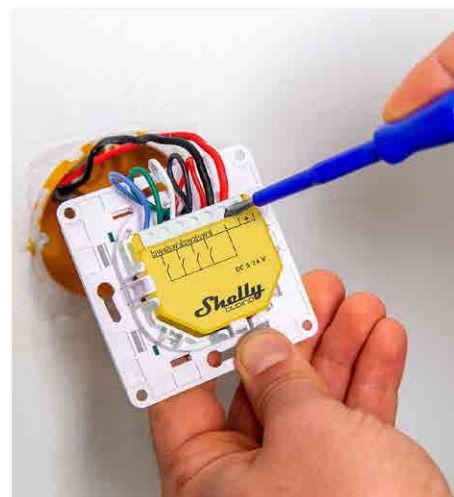

Shelly Wave Plug UK



MAKE ANY OLD ELECTRICAL APPLIANCE SMART

There is no need to invest in expensive smart appliances. If you have an old space heater, don't let go of it just yet! Instead, make it smart by simply plugging it into Wave Plug UK! Then, create a scene and have the heater turn on when the room temperature drops below your desired level. And the cherry on top? You always know how much energy you are consuming!



NO MORE FORGOTTEN APPLIANCES

Have you left an appliance running at home, wasting energy or causing damage? With Wave Plug UK, you can control and monitor all plugged-in appliances easily and simply with just a click or set scenes, so forgotten devices can automatically switch off after a pre-set time to save energy or, even more importantly, to prevent damage.



Z-Wave® operated

Include Wave Plug UK to your Z-Wave network and control it remotely. It's compatible with all certified Z-Wave gateways.



Wide variety of appliances supported

Use it to control a wide range of devices and appliances with a power of up to 3000 W (resistive) at 13 A.



Power monitoring

Wave Plug UK provides precise monitoring of the power consumption, indicated by the colour of the LED ring.



Associations

Establish direct communication between devices in your Z-Wave local network and set actions with no hub present!



Smart Schedules

Set custom schedules based on your daily agenda or automatically follow the sunrise/sunset and control your appliances accordingly (gateway required).



Smart Scenes

Set custom scenes by combining Wave Plug UK with any other Z-Wave devices (gateway required).

THE Z-WAVE SMART PLUG WITH LED INDICATIONS

Shelly Wave Plug UK is a Z-Wave smart plug with power metering that allows you to automate and remotely control a space heater, iron, TV, or any other connected electrical appliance at home with a power capacity of up to 3000 W at 13 A. Its LED indication ring keeps you informed about the current power consumption and the current state of the appliance (e.g. if overcurrent or overheating is detected).

TECHNICAL SPECIFICATIONS

Power supply	230 VAC, 50/60 Hz
Max. switching current AC	13 A
Complies with EU standards	<ul style="list-style-type: none">• RED 2014/53/EU• LVD 2014/35/EU• EMC 2014/30/EU• RoHS2 2011/65/EU
Working temperature	-20°C to 40°C / -5°F to 105°F
Humidity	30% to 70% RH
Z-Wave® frequency band	868,4 MHz
Operational range (depending on local conditions)	Up to 40 m / 131 ft indoors (depends on local condition)
Processor (CPU)	Z-Wave® S800
Compatible sockets	BS 1363 (Type-G)
Compatible plugs	BS 1363 (Type-G)
Dimensions (HxWxL)	60x60x56 mm / 2.36x2.36x2.20 in
Power consumption	< 0.7 W

By using Z-Wave, smart home products can seamlessly communicate with each other, regardless of their brand or platform, thanks to a centralized smart hub! Shelly Qubino devices work on the latest Z-Wave chip generation (S800), one of the most popular standardized technologies for smart homes in the world.

*Z-Wave devices have specific requirements in order to function correctly, such as the necessity to use a supported Z-Wave hub. For more information, please visit the official Z-Wave website: www.z-wave.com

Shelly Wave Plug US

Available only in US



FORECAST AND OPTIMIZE YOUR UTILITY EXPENSES

Wave Plug US allows you to monitor the real-time energy consumption of all switched-on devices or their energy consumption over a certain period. And by doing so - discover energy wastes or forecast and optimize your expenses.



FAMILY-FRIENDLY DEVICE

Are your kids having vacations while you're at work, worrying that they might spend the entire day watching TV? Wave Plug US is a family-friendly device, as you can set schedules to limit TV/computer time for your teenager, or it can help you prevent unnecessary energy consumption by automatically turning off your kids' toy chargers.



Z-Wave® operated

Include Wave Plug US to your Z-Wave network and control it remotely. It's compatible with all certified Z-Wave gateways.



Wide variety of appliances supported

Use it to control a wide range of devices and appliances with a power of up to 1800 W at 15 A.



Power monitoring

Wave Plug US provides precise monitoring of the power consumption.



Associations

Establish direct communication between devices in your Z-Wave local network and set actions with no hub present!



Smart Schedules

Set custom schedules based on your daily agenda or automatically follow the sunrise/sunset and control your appliances accordingly (gateway required).



Smart Scenes

Set custom scenes by combining Wave Plug US with your other Shelly Qubino devices (gateway required).

THE Z-WAVE SMART PLUG THAT FITS EVERYWHERE

Shelly Wave Plug US is a Z-Wave smart plug with power metering that allows you to automate and remotely control a space heater, iron, TV, or any other connected electrical appliance at home with a power capacity of up to 1800 W at 15 A. Simply plug your standard space heater into Wave Plug US, enabling you to conveniently switch it on and off at any time and from anywhere with just a single click on your phone.

TECHNICAL SPECIFICATIONS

Power supply	120 VAC, 60 Hz
Max. switching current AC	15 A
Working temperature	-20°C to 40°C / -5°F to 105°F
Humidity	30% to 70% RH
Z-Wave® frequency band	908,4 MHz
Operational range (depending on local conditions)	Up to 40 m / 131 ft indoors (depends on local condition)
Dimensions (HxWxL)	38x84x52 mm / 1.5x3.3x2.0 in
Processor (CPU)	Z-Wave® S800
Compatible sockets	NEMA 5-15 (Type-B)
Compatible plugs	NEMA 1-15 (Type-A) and NEMA 5-15 (Type-B)
Power consumption	< 0.3 W

Wave Plug US with Plug & Play installation instantly transforms any connected electrical appliance into a smart one. Once plugged in, include it in your Z-Wave network (Z-Wave gateway is required) and control connected appliances from anywhere using your smartphone or tablet. Shelly Qubino devices work with over 4000 Z-Wave certified devices and gateways.

Shelly Wave Pro 1



Dynamic lights control for improved efficiency

Automate your lights and optimize their energy consumption through smart schedules, scenes, actions, etc. Wave Pro 1 allows you to automate the lights on each floor separately and set custom schedules for each of them. Set all lights in the office to switch off when everyone has left the premises and never worry about wasting energy during non-working hours.



Common space automation

Common spaces such as halls, garages, and storage rooms usually have their lights constantly switched on, which leads to inefficient usage of energy and unnecessary monthly costs. Set the actions, so the motion sensor* will trigger the Wave Pro 1 to switch the lights on when someone enters and switch them off once the premises are empty. This will ensure the most efficient use of the lights in the common spaces.

*Any Z-Wave motion sensor can be used with Wave Pro 1



Z-Wave® operated

Include Wave Pro 1 to your Z-Wave network and control it remotely. It's compatible with all certified Z-Wave gateways.



1 channel, 16 A

It has a total device output of 16 A.



Dry contacts

Supporting low and high voltages, this device enables you to control a wide range of AC devices and appliances.



DIN-mountable

Intended to be installed inside the breaker box and designed to meet the global DIN rail standardization.



Associations

Establish direct communication between devices in your Z-Wave local network and set actions with no hub present!



The highest level of security

Include the device as Security 2 Authenticated for encrypted communication and utmost safety of your Z-Wave network.

THE BEST SOLUTION FOR NEW HOME BUILDINGS AND BUSINESS FACILITIES

Shelly Wave Pro 1 is a one-phase, 1 channel relay supporting up to 16 A for professional lights and appliance automation in residential or commercial applications. It is equipped with potential-free outputs (dry contacts) offering high flexibility in voltage support and applications. Different types of actions, scenarios, and schedules can be set to sync your environment to your daily activities or business needs.

TECHNICAL SPECIFICATIONS

Power supply	110-240 VAC, 50/60 Hz;
Max. switching current AC	16 A
Complies with EU standards:	<ul style="list-style-type: none"> • RED 2014/53/EU • LVD 2014/35/EU • EMC 2014/30/EU • RoHS2 2011/65/EU
Working temperature	-20°C to 40°C / -5°F to 105°F
Z-Wave® frequency bands	868,4 MHz
Power consumption	< 0,3 W
CPU	Z-Wave® S800
Operational range (depending on local conditions)	Up to 40 m / 131 ft indoors (depends on local condition)
Dimensions (HxWxD)	94x19x69 mm / 3.70x0.75x2.71 in
Mounting	DIN rail
Wire cross section range	0.5 to 2.5 mm ² / 20 to 14 AWG (green connector) 0.5 to 1.5 mm ² / 20 to 16 AWG (white connectors)

HOW TO CONNECT

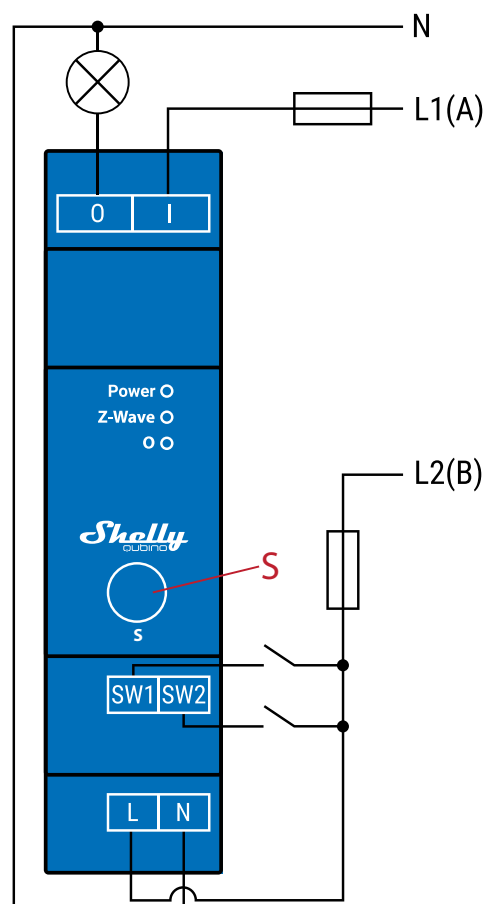

Legend

Device terminals:

- N:** Neutral terminal
- L:** Live terminal (110–240 V AC)
- SW (SW1):** Switch/push-button input terminal (controlling O (O1))
- SW2:** Switch/push-button input terminal
- I:** Load circuit input terminal
- O (O1):** Load circuit output terminal (1)
- Wires:**
- N:** Neutral wire
- L1(A):** Load circuit live wire (110-240 V AC)
- L1(B):** Device power supply live wire (110-240 V AC)
- Button:**
- S:** S button



Control lights on 2 phases

Automate the lights and optimize their energy consumption through smart schedules, timers, scenarios, etc. Wave Pro 2 allows you to control the lights on 2 phases and manage them separately by setting custom schedules and smart timers. Set the lights on the operational floors to switch off completely after the working day is over and switch back on only where it is necessary at 7:00 in the morning. This way, you will not have to worry about any forgotten lights or efficiency.

Sockets automation for efficient energy usage

Make sure that no energy goes to waste by automating the sockets' power supply with Wave Pro 2 and use the smart scheduling to cut off the power to all non-essential heavy consuming electrical appliances in offices between 7:00 PM and 7:00 AM during the weekdays and over the weekend. That way, you will cut the energy consumption of these devices in half, which will result in significant optimization of the monthly energy cost.



Z-Wave® operated

Include Wave Pro 2 to your Z-Wave network and control it remotely. It's compatible with all certified Z-Wave gateways.



2 outputs, 16 A each

It has a total device output of 25 A.



Dry contacts

Supporting low and high voltages, this device enables you to control a wide range of AC devices and appliances.



DIN-mountable

Intended to be installed inside the breaker box and designed to meet the global DIN rail standardization.



Associations

Establish direct communication between devices in your Z-Wave local network and set actions with no hub present!



The highest level of security

Include the device as Security 2 Authenticated for encrypted communication and utmost safety of your Z-Wave network.

THE BEST SOLUTION FOR NEW HOME BUILDINGS AND BUSINESS FACILITIES

Shelly Wave Pro 2 is a two-phase, 2-channel relay supporting up to 25 A for professional lights and appliance automation for residential or commercial use. It is equipped with potential-free outputs (dry contacts), offering high flexibility in voltage support and applications. Different types of actions, scenarios, and schedules can be set to sync your environment to your daily activities or business needs.

TECHNICAL SPECIFICATIONS

Power supply	110-240 VAC, 50/60 Hz;
Max. switching current AC	16 A per channel, 25 A total
Complies with EU standards:	<ul style="list-style-type: none"> • RED 2014/53/EU • LVD 2014/35/EU • EMC 2014/30/EU • RoHS2 2011/65/EU
Working temperature	-20°C to 40°C / -5°F to 105°F
Z-Wave® frequency bands	868,4 MHz
Power consumption	< 0,3 W
CPU	Z-Wave® S800
Operational range (depending on local conditions)	Up to 40 m / 131 ft indoors (depends on local condition)
Dimensions (HxWxD)	94x19x69 mm / 3.70x0.75x2.71 in
Mounting	DIN rail
Wire cross section range	0.5 to 2.5 mm ² / 20 to 14 AWG (green connector) 0.5 to 1.5 mm ² / 20 to 16 AWG (white connectors)

HOW TO CONNECT

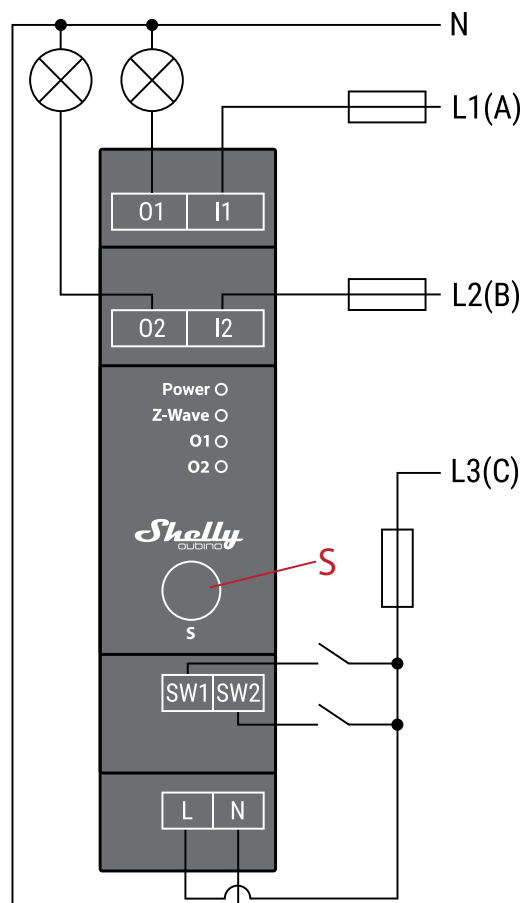

Legend

Device terminals:

- N:** Neutral terminal
- L:** Live terminal (110–240 V AC)
- SW (SW1):** Switch/push-button input terminal (controlling 0 (O1))
- SW2:** Switch/push-button input terminal
- I1:** Load circuit 1 input terminal
- I2:** Load circuit 2 input terminal
- O (O1):** Load circuit output terminal (1)
- O2:** Load circuit 2 output terminal

Wires:

- N:** Neutral wire
- L1(A):** Load circuit live wire (110-240 V AC)
- L1(B):** Device power supply live wire (110-240 V AC)
- L3(C):** Device power supply live wire (110-240 V AC)

Button:

- S:** S button

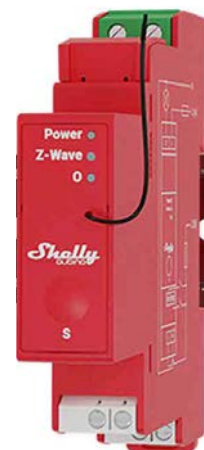

Preventative management

When an electrical appliance is damaged, it doesn't simply stop working. Usually, it increases the amount of energy used in an attempt to compensate for its operational capacity. Since there is no visible difference in its performance, it might take months before you can identify a problem, leading to inefficiency and wasted energy. Wave Pro 1PM, however, will immediately report the increase in energy consumption and will save you additional expenses on repairs or replacement of equipment.



Avoid unnecessary energy usage by controlling the office equipment power supply

Stop unnecessary energy usage in the office over the weekend! Computers and monitors that somebody forgot to turn off, plugged chargers, lit up desk lights, printers and copy machines left switched on, etc. - all these appliances are consuming energy when nobody is in the office, unnecessarily burdening the monthly bills. Avoid that by setting Wave Pro 1PM to cut off the power supply of the office appliances over the weekend to save on energy. Use smart scheduling functions to restore the power supply before the employees arrive at the office.



Z-Wave® operated

Include Wave Pro 1PM to your Z-Wave® network and control it remotely. It's compatible with all certified Z-Wave gateways.



1 channel, 16 A

Wave Pro 1PM has a total device output of 16 A.



Power monitoring

Wave Pro 1PM provides precise monitoring of the power consumption.



Wide range of voltage support

Use it to control a wide range of AC devices and appliances.



Associations

Establish direct communication between devices in your Z-Wave local network and set actions with no hub present!



The highest level of security

Include the device as Security 2 Authenticated for encrypted communication and utmost safety of your Z-Wave network.

THE BEST SOLUTION FOR NEW HOME BUILDINGS AND BUSINESS FACILITIES

Shelly Wave Pro 1PM is a one-phase, 1-channel relay supporting up to 16 A. Equipped with an integrated power meter, Wave Pro 1PM allows you to measure the power consumption of all automated lights or heavier appliances. Different types of actions, scenarios, and schedules can be set to sync your environment to your daily activities or business needs.

TECHNICAL SPECIFICATIONS

Power supply	110-240 VAC, 50/60 Hz;
Max. switching current AC	16 A per channel
Complies with EU standards:	<ul style="list-style-type: none"> • RED 2014/53/EU • LVD 2014/35/EU • EMC 2014/30/EU • RoHS2 2011/65/EU
Working temperature	-20°C to 40°C / -5°F to 105°F
Z-Wave® frequency bands	868,4 MHz
Power consumption	< 0,3 W
CPU	Z-Wave® S800
Operational range (depending on local conditions)	Up to 40 m / 131 ft indoors (depends on local condition)
Dimensions (HxWxD)	94x19x69 mm / 3.70x0.75x2.71 in
Mounting	DIN rail
Wire cross section range	0.5 to 2.5 mm ² / 20 to 14 AWG (green connector) 0.5 to 1.5 mm ² / 20 to 16 AWG (white connectors)

HOW TO CONNECT

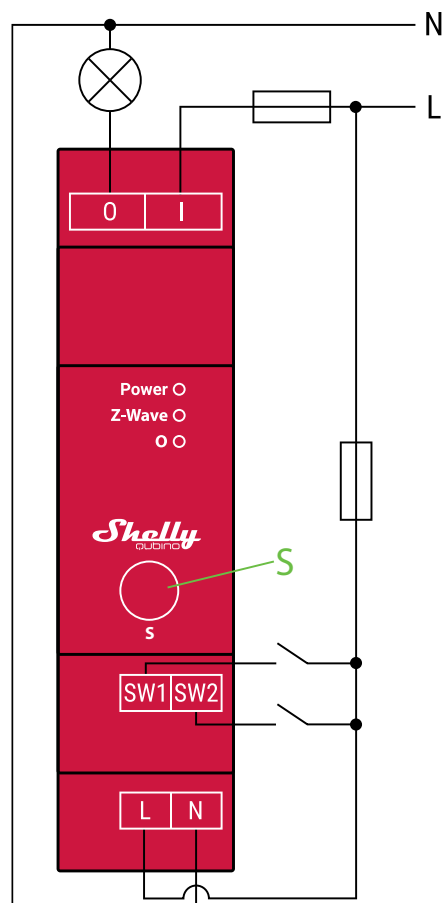

Legend

Device terminals:

- N:** Neutral terminal
- L:** Live terminal (110–240 V AC)
- SW (SW1):** Switch/push-button input terminal (controlling O (O1))
- SW2:** Switch/push-button input terminal
- I:** Load circuit 1 input terminal
- O (O1):** Load circuit output terminal (1)

Wires:

- N:** Neutral wire
- L:** Live wire (110-240 V AC)

Button:

- S:** S button



Dynamic lights control for improved efficiency

Automate your lights and optimize their energy consumption through smart schedules, scenes, actions, etc. Wave Pro 2PM allows you to automate the lights on each floor separately and set custom schedules for each of them. Set all lights in the office to switch off when everyone has left the premises and never worry about wasting energy during non-working hours.



Smart conference room

Automate the conference rooms so that they are fully ready for your business meetings. Establish a local (direct) communication between Z-Wave devices within your network and execute actions without Z-Wave gateway. The motion sensor* will trigger the Wave Pro 2PM to turn on the lights and the projector, so the conference room is instantly ready for your presentation!

*Any Z-Wave motion or door sensor can be used with Wave Pro 2PM



Z-Wave® operated

Include Wave Pro 2PM to your Z-Wave network and control it remotely. It's compatible with all certified Z-Wave gateways.



2 outputs, 16 A each

Wave Pro 2PM has a total device output of 25 A.



Power metering

Wave Pro 2PM provides precise monitoring of the power consumption on each channel (W) or together (W, kWh).



Wide range of voltage support

Use it to control a wide range of AC devices and appliances.



Associations

Establish direct communication between devices in your Z-Wave local network and set actions with no hub present!



The highest level of security

Include the device as Security 2 Authenticated for the encrypted communication and utmost safety of your Z-Wave network.

THE BEST SOLUTION FOR NEW HOME BUILDINGS AND BUSINESS FACILITIES

Wave Pro 2PM is a one-phase, 2-channel relay, supporting up to 16 A per channel with a total device capacity of 25 A. It is equipped with two integrated power meters that allow customers to control and monitor the consumption for each channel separately and or together. Different types of actions, scenarios, and schedules can be set to sync your environment to your daily activities or business

TECHNICAL SPECIFICATIONS

Power supply	110-240 VAC, 50/60 Hz;
Max. switching current AC	16 A per channel, 25 A total
Complies with EU standards:	<ul style="list-style-type: none"> • RED 2014/53/EU • LVD 2014/35/EU • EMC 2014/30/EU • RoHS2 2011/65/EU
Working temperature	-20°C to 40°C / -5°F to 105°F
Z-Wave® frequency bands	868,4 MHz
Power consumption	< 0,3 W
CPU	Z-Wave® S800
Operational range (depending on local conditions)	Up to 40 m / 131 ft indoors (depends on local condition)
Dimensions (HxWxD)	94x19x69 mm / 3.70x0.75x2.71 in
Mounting	DIN rail
Wire cross section range	0.5 to 2.5 mm ² / 20 to 14 AWG (green connector) 0.5 to 1.5 mm ² / 20 to 16 AWG (white connectors)

HOW TO CONNECT

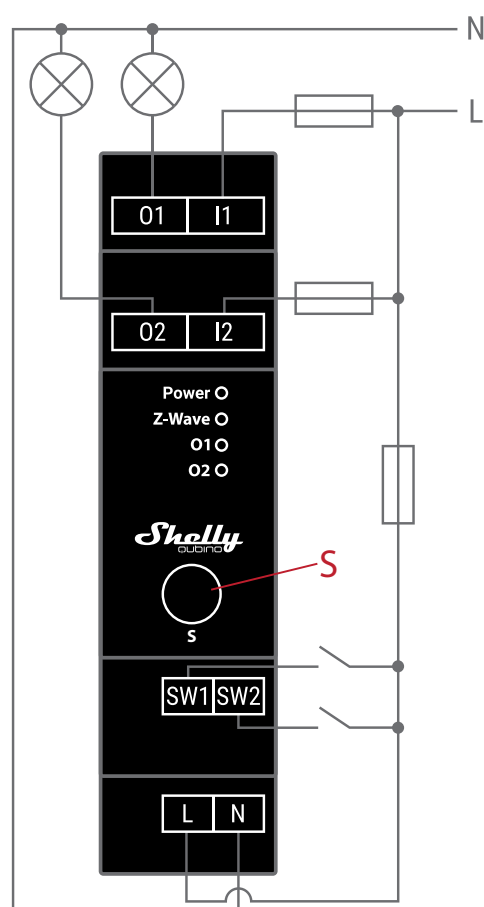

Legend

Device terminals:

- N:** Neutral terminal
- L:** Live terminal (110–240 V AC)
- SW (SW1):** Switch/push-button input terminal (controlling O (O1))
- SW2:** Switch/push-button input terminal (controlling O2)
- I1:** Load circuit 1 input terminal
- I2:** Load circuit 2 input terminal
- O (O1):** Load circuit 1 output terminal
- O2:** Load circuit 2 output terminal

Wires:

- N:** Neutral wire
- L:** Live wire (110-240 V AC)

Button:

- S:** S button

Shelly[®] dimmer2

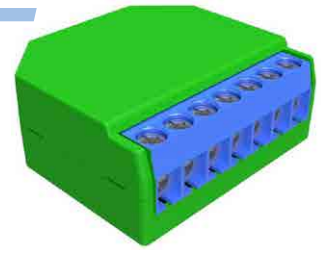

SMALL SIZE FULL OF FUNCTIONALITIES



Intelligently designed to fit in most standard electrical boxes and switches. Shelly Dimmer 2 is a tiny device offering an array of dimming functionalities.



No additional controller

Shelly Dimmer 2 uses your home Wi-Fi network, no additional controllers are needed.



On/off and dimming function

With Shelly Dimmer 2 you can turn on/off or use dimming function to set your lights to your preference.



Overheating protection

Internal temperature sensor for overheating protection.



Support 100-240V~ 50/60Hz

With Shelly Dimmer 2 you can use incandescent and halogen lights: 10-220W, dimmable LED lights: 50-200VA / 10W – 200W or resistive-inductive loads: ferromagnetic transformers 50-150VA.



Free Cloud

All you need to manage your Shelly Dimmer 2 is a smartphone and the Shelly Cloud free mobile application.

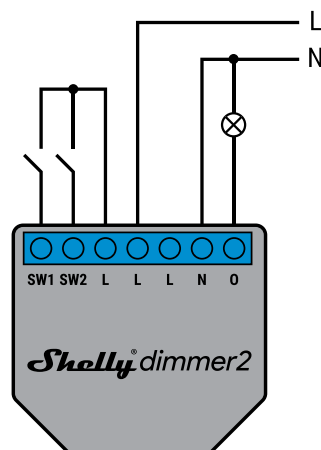

Standard wiring
with neutral

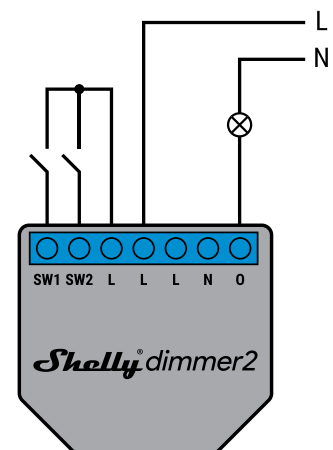

No neutral
wiring

CREATE THE PERFECT HOME ATMOSPHERE THAT SUITS YOUR MOOD

Dimming without a neutral line. We developed Shelly Dimmer 2 to be able to cover all possible electrical installations all over the world. Shelly Dimmer 2 can be used in houses where the neutral line is missing and provide a full set of dimming functionalities.

TECHNICAL SPECIFICATIONS

Power Supply	110-230 VAC, 50/60 Hz
Can work without neutral line	Yes
Complies with EU standards	<ul style="list-style-type: none"> • RED 2014/53/EU • LVD 2014/35/EU • EMC 2014/30/EU • RoHS2 2011/65/EU
Working temperature:	0 to 35°C
Max RF power	13 dBm
Radio protocol	Wi-Fi 802.11 b/g/n
Frequency	2401- 2495 MHz
Operational range (depending on local conditions)	<ul style="list-style-type: none"> • Up to 30 m / 100 ft indoors • Up to 50 m / 160 ft outdoors
Dimensions	43x37x14 mm / 1.69x1.45x0.55 in
Electrical consumption	< 1 W
Wire cross section range	0.5 to 1.5 mm ² / 20 to 16 AWG

Use with any bulb you want

Shelly Dimmer 2 can be used with a variety of light bulbs. From halogen and incandescent lights to dimmable LED and resistive - inductive load ferromagnetic transformers.

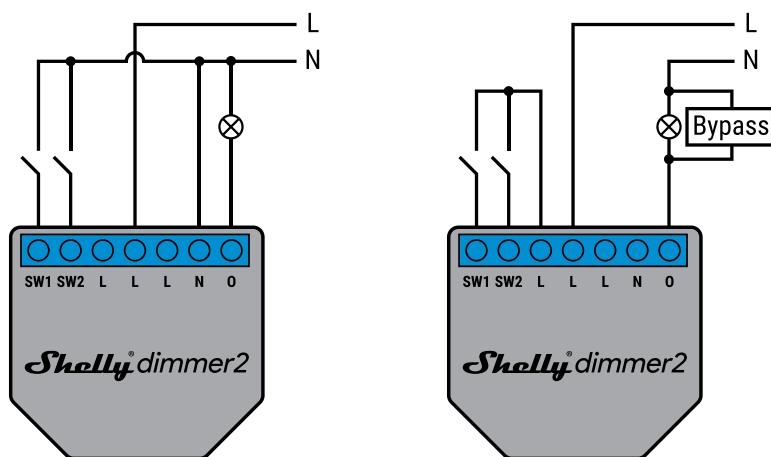
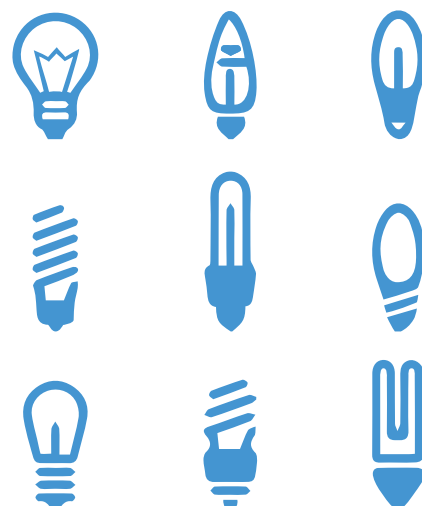

Standard wiring with neutral and SW connected to neutral

No neutral wiring with no minimum load requirements

Legend

Device terminals:

- SW1:** Switch 1 input terminal
- SW2:** Switch 2 input terminal
- L:** Live (110-240 VAC) terminals
- N:** Neutral terminal
- O:** Load circuit output terminal

Wires:

- L:** Live (110-240 VAC) wire
- N:** Neutral wire

Shelly[®] RGBW2



POWER ON



Get a 110–220 VAC to 12-24 VDC

SHELLY RGBW2



Connect Shelly RGBW2 to the power transformer

LED STRIPS AND/OR BULBS



Support any 12V or 24 V White, RGB, RGBW led strips and 12/24 V led bulbs, with up to 288 W combined power



Wireless

No HUB required – Connect Shelly RGBW2 directly to your Wi-Fi at home.



Weekly Schedules

Choose a time and set your hidden lighting to turn on/off or change color.



Sunrise/Sunset Schedules

Shelly RGBW2 will automatically follow the sunrise and sunset and can control your lighting accordingly.



Color Effects

The 6 unique colorful effects will set the mood for your party or help you relax at home.



Control Remotely

Control the LED lighting at home, no matter where you are. Now you won't be leaving the lights on and your home won't welcome you in darkness.



Highly Compatible

Compatible with Android, iOS, Amazon Alexa and Google Assistant.



Support 12V or 24V

With Shelly RGBW2 you can use White, RGB, RGBW led strips and 12/24V led bulbs, with up to 288W combined power.



ON/OFF and Dimming Function

No more forgotten turned on appliances. The integrated count-down timer can automatically switch off your lights after an hour.

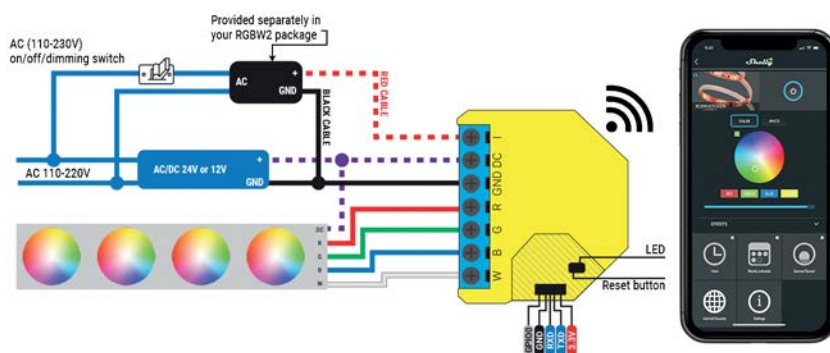

WI-FI RGBW LED CONTROLLER

Make your LED strips smart without additional investment. **Shelly RGBW2** connects like any LED controller. The main benefit is that you will be able to control your light directly from your mobile phone.

TECHNICAL SPECIFICATIONS

Interfaces	
Output interface	4 ways PWM: R/G/B/W 3 ways PWM: R/G/B 4 ways PWM: 4x White strips or 4x12/24 V LED bulbs
Interface	Reset button, AC 230 V switch input
AC switch	On/Off and Dimming function
Wi-Fi Parameters and Features	
Wi-Fi work mode	STA/AP/STA+AP/Smart Config
Security Specialty	None, WEP, WPA-PSK, WPA2-PSK (TKIP/AES)
Wi-Fi Standard	IEEE 802.11b/g/n
Wi-Fi Power	802.11b (CCK) 11 Mbps: 20+/-1.5 dBm
	802.11g (OFDM) 54 Mbps: 15.5+/-1.5 dBm
	802.11n(HT20@MCS7) 72.2 Mbps: 14.5+/-1.5 dBm
Frequency	2401- 2495 MHz
Antenna	Embedded
Power Input/output	
DC Power Input	12-24 V
DC Power Output 12V	144 W - combined power; 45 W - per channel
DC Power Output 24V	288 W - combined power; 90 W - per channel
Standby Current	≤50 mA
Work environment	
Working temperature	-20°C to 40°C / -5°F to 105°F
Work humidity	5% to 95% (No condensing)
Wi-Fi Range	Indoor: 35m, Outdoor: 60m (depending on the environment)
Dimensions (HxWxL)	43x38x14 mm / 1.69x1.49x0.55 in
Wire cross section range	0.5 to 1.5 mm ² / 20 to 16 AWG

- Focus on 8~36 W lamps such as droplight, ceiling lamp, table lamp, down lamp or other
- Support 5 ways PWM, applied to control 5 colors LED(R/G/B/CW/WW),
- Offers mobile phone App, supporting iOS and Android
- Configure network via the mobile App
- Supports local and remote control
- Supports Weekly Schedules
- Supports Sunrise/Sunset time based Schedules
- 6 color effects

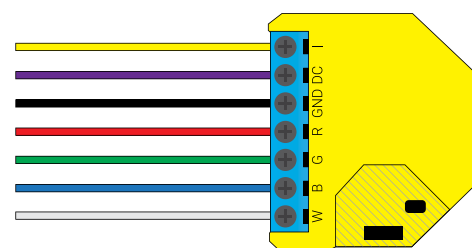

Legend

- AC or DC on/off/dimming switch
- + 12/24 VDC
- - 12/24 VDC
- Red Light
- Green Light
- Blue Light
- White Light

Shelly[®] EM



MEASUREMENTS

- ✓ 2x Power(W)
- ✓ 2x Current(A)
- ✓ 2x Energy(Wh)
- ✓ 2x Load quality
- ✓ 1x Voltage(V)



ADDITIONAL FEATURES

- ✓ 365 days built-in energy history
- ✓ Switch output for contactor control



Wi-Fi Connected

Shelly EM can connect directly to any Wi-Fi network, no HUB required or can operate as an Access Point.



Power Supply

Shelly EM is compatible with all major international voltage standards.



Dual Power Metering

Shelly EM can monitor in real time the energy consumption simultaneously in 2 circuits on the same phase. (up to 120 A each).



Contactor Control

2A / 230V 50/60Hz. Shelly EM has integrated device output made for contactor control.



Mobile app control

Turn devices on/off directly from your smartphone or tablet. You can manage Shelly EM output from Shelly app, MQTT or Rest API.



Overconsumption and Over Energy Protection

No more forgotten turned on appliances. The integrated countdown timer can automatically switch off your oven after an hour.



Embedded Web Server

Turn on/off Shelly devices directly from its interface without the need of any additional controller or hub, thanks to the embedded web.



Sunrise/Sunset Schedules

Shelly EM can automatically turn on/off based on the sunrise and sunset hours.



Weekly Schedules

Choose a time and create custom daily schedules for your devices.

WI-FI-OPERATED ENERGY METER AND CONTACTOR CONTROL

With **Shelly EM** you can measure how much energy your solar system produces.

TECHNICAL SPECIFICATIONS

Power supply	110-240 VAC, 50/60 Hz
Power metering	Two channels, up to 120 A each
Consumption history	365 days built-in energy history (Wh)
Maximum load	2 A / 240 VAC
Complies with EU standards:	<ul style="list-style-type: none">• RED 2014/53/EU• LVD 2014/35/EU• EMC 2014/30/EU• RoHS2 2011/65/EU
Working temperature	0°C to 40°C / -32°F to 105°F
Max RF power:	13 dBm
Wireless/Wi-Fi Protocol	802.11 b/g/n (2.4 GHz)
Frequency	2401- 2495 MHz
Operational range (depending on local conditions)	<ul style="list-style-type: none">• Up to 30 m / 100 ft indoors• Up to 50 m / 160 ft outdoors
Dimensions (HxWxL)	39x36x17 mm / 1.53x1.41x0.66 in
Electrical consumption:	< 1 W
Additional features	<ul style="list-style-type: none">• Overpower shutdown• Consumption limit
Wire cross section range	0.5 to 1.5 mm ² / 20 to 16 AWG



CONTROL 120 A SAFE AND EASY

Shelly EM has integrated switch output made for contactor control

- **Remote control from anywhere**

You can manage ShellyEM output from Shelly app, MQTT or Rest API

- **Overpower Control**

Automatic shutdown or notification when reaching current consumption limit.

- **Turn off when total consumption is reached**

Automatic shutdown when power is reached.

- **Weekly scheduling by time or sun position**

Auto turn on and off by hour or sunset and sunrise.

Shelly® 3EM



- ✓ Precise 3-phase energy metering
- ✓ Up to 120 A per phase
- ✓ Integrated 10 A contactor control
- ✓ Solar and Wind power compatible
- ✓ Factory calibrated with over 99% accuracy
- ✓ DIN mountable
- ✓ Wi-Fi enabled
- ✓ Cloud and MQTT Enabled
- ✓ 365 days power consumption history



Wi-Fi connected

Shelly 3EM can be connected to any Wi-Fi network or can operate as an Access Point.



Power supply

Each phase of Shelly 3EM must be 110-230 VAC, 50/60Hz.



Monophase systems

Shelly 3EM can also monitor monophase electrical systems with up to 3 points simultaneously.



Contactor control

Shelly 3EM has an integrated 10 A switch output for contactor control.



Mobile app control

Turn Shelly 3EM on/off directly from your smartphone or tablet. You can manage Shelly 3EM's output from the Shelly Smart Control App, MQTT or Rest API.



Overconsumption and overpower protection

Shelly 3EM can automatically turn off the whole circuit if consumption or energy (pre-paid energy option) reaches the set limit.



Embedded web server

Turn on/off Shelly 3EM's contactor output directly, without the need of any additional controller or hub.



Sunrise/sunset schedules

Shelly 3EM can automatically turn on/off the power based on the sunrise/sunset hours.



Weekly schedules

Choose a time and create custom daily schedules for your Shelly 3EM.

WI-FI-OPERATED 3 PHASE ENERGY METER AND CONTACTOR CONTROL

Shelly 3EM has integrated output which can be used for contactor control.

TECHNICAL SPECIFICATIONS

Power supply	110-230 VAC, 50/60 Hz
Power metering	3 channels, up to 120 A each
Consumption history	365 days built-in energy history (Wh)
Maximum load	10 A / 240 VAC
Complies with EU standards	<ul style="list-style-type: none"> • RED 2014/53/EU • LVD 2014/35/EU • EMC 2014/30/EU • RoHS2 2011/65/EU
Working temperature	-20°C to 40°C / -5°F to 105°F
Max RF power	10.28 dBm
Wireless/Wi-Fi Protocol	802.11 b/g/n (2.4 GHz)
Frequency	2401- 2495 MHz
Operational range (depending on local conditions)	<ul style="list-style-type: none"> • Up to 30 m / 100 ft indoors • Up to 50 m / 160 ft outdoors
Dimensions (HxWxD)	73x22x58 mm / 2.87x0.86x2.28 in
Electrical consumption	< 1 W
Additional features	<ul style="list-style-type: none"> • Overpower shutdown • Consumption limit

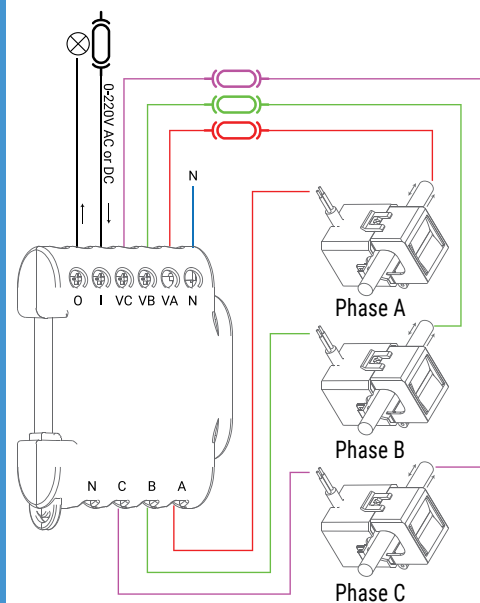

Shelly[®] PLUG



SHELLY PLUG SAVES YOU ENERGY AND MONEY



WITH SHELLY PLUG YOU CAN CONTROL ANY DEVICE AT YOUR HOME FROM ANYWHERE



WITH SHELLY PLUG YOU MAY OPTIMIZE YOUR TIME



Wi-Fi Connected

Shelly™ Plug can connect to any Wi-Fi network or can operate as an Access Point.



Power Consumption

Shelly™ Plug has an integrated precise power meter. You can measure the overall consumption of all the electric devices you are controlling.



Free Cloud

All you need to manage your Shelly Plug is a smartphone and the Shelly Cloud free mobile application.



Follow the sunlight

Shelly Plug can automatically turn on/off based on the sunrise and sunset hours.



Weekly scheduling

Create custom daily schedules for your devices.



Mobile app control

You can turn on and off your appliances from anywhere in the world.



Countdown timer

No more forgotten turned on appliances. The integrated countdown timer can automatically switch off your oven after an hour.



Up To 3500W

With Shelly Plug you can control wide range of devices and appliances.



Highly compatible

Compatible with Android, iOS, Amazon Alexa and Google Assistant.

SMART WI-FI-OPERATED PLUG WITH POWER MEASUREMENTS AND 16 A MAX LOAD

Shelly Plug automatically monitors and controls lightning, heating and any other connected electrical appliance in your house, no matter where you are. When an electric appliance or a lamp is plugged into the Shelly Plug, you can switch it on and off through the Shelly Cloud mobile application. You can do it anytime and from anywhere.

TECHNICAL SPECIFICATIONS

Power supply	Input 110-230 VAC, 50/60 Hz
Max load	16 A / 230 V
Complies with EU standards	<ul style="list-style-type: none">• RED 2014/53/EU• LVD 2014/35/EU• EMC 2014/30/EU• RoHS2 2011/65/EU
Working temperature	-20°C to 40°C / -5°F to 105°F
Max RF power	15 dBm
Wireless/Wi-Fi Protocol	802.11 b/g/n (2.4 GHz)
Frequency	2401- 2495 MHz
Operational range (depending on local conditions)	<ul style="list-style-type: none">• Up to 30 m / 100 ft indoors• Up to 50 m / 160 ft outdoors
Dimensions (HxWxL)	98x56x35 mm / 3.85x2.20x1.37 in
Processor (CPU)	Texas Instruments CC3200
Remote Control	Trough mobile app & web interface
Compatibility	Android (4.2+) & iOS (8+), web browsers
Languages	Multiple trough mobile app & web interface
Electrical consumption	< 1 W

- Control through Wi-Fi from a mobile phone, PC, automation system or any other device supporting HTTP and/or UDP protocol.
- Microprocessor management.
- Controlling elements: 1 switch.
- Shelly may be controlled by the integrated button.

Shelly[®] button 1



1 BUTTON - 4 ACTIONS

No more stressful bright light during dark hours early in the morning. Set your custom schedule and choose soft and low light while it is still dark outside when.

- 1X - Bedroom light On/Off
- 2X - Blinds are closed
- 3X - Turn fan On/Off
- Long push - Turn Off all lights



No additional controller

Shelly Button 1 uses your home Wi-Fi network, no additional controllers are needed.



Built-in Battery

Shelly Button 1 has built-in rechargeable battery allowing more than 3000 actions per charge.



Color hints

A different color response indication for different situations.



USB charging

You can charge Shelly Button 1 with Micro-B type USB cable.



Low-battery alarm

You can set Shelly Button 1 to inform you when the battery levels are low.



Quick response

Response time of less than 2s on battery and 0,1s on USB power.



Highly compatible

Shelly Button1 is Cloud connected but can also be connected via MQTT, CoAP, REST API.

CONTROL EVERYTHING WITH JUST A CLICK

We developed Shelly Button to help you easily activate or deactivate any device or scene manually with just a click. Additionally, Shelly Button is so tiny it can be put and carried around anywhere. The button is battery-powered, and you can put it in your bag, laptop case, or even in your pocket and use it whenever and wherever you need it.

TECHNICAL SPECIFICATIONS

Power Supply	Two 3 VDC - CR123A Batteries or micro USB 5 V
Battery Lifespan	3000 actions per charge
Complex scenes control	Activate or deactivate synchronized actions of several Shelly devices
Dimming	Yes
Complies with EU standards	<ul style="list-style-type: none">• RED 2014/53/EU• LVD 2014/35/EU• EMC 2014/30/EU• RoHS2 2011/65/EU
Working temperature	0°C to 40°C / 32°F to 105°F
Max RF power	10.62 dBm
Radio protocol	Wi-Fi 802.11 b/g/n
Frequency	2401- 2495 MHz
Operational range (depending on local conditions)	<ul style="list-style-type: none">• Up to 30 m / 100 ft indoors• Up to 50 m / 160 ft outdoors
Dimensions	45x45x16 mm / 1.77x1.77x0.62 in

SMALL AND MOBILE

Thanks to its small size, Shelly Button 1 can fit in every pocket!



Shelly Motion2



COMPATIBLE WITH OTHER DEVICES

Shelly Motion2 can trigger other smart devices in your home network and customize the actions based on hour, light, or various actions.



LIGHTING CONTROL

Combine Shelly lighting control devices with Shelly Motion2 and set the sensor to turn on the lights the moment you enter the room.



SMART SCHEDULING

Don't wake up your family during your night-time snack! Set Shelly Motion2 smart scheduling option to turn on the lights very dimly at late hours. That way it will not irritate your eyes or wake your loved ones.



Wi-Fi operated

Connect Shelly Motion2 to your Wi-Fi network. No HUB required!



Over 1 year battery life

Count on long-lasting 6500 mAh rechargeable battery.



Real time response

Response in less than 200 ms and immediate action trigger to another device.



Light Sensor Included

Shelly Motion2 is enhanced with a light sensor for dynamic adjustment of the brightness levels.



Temperature Sensor Included

Shelly Motion2 has a temperature sensor.



Powerful CPU

Equipped with the lowest power consuming Wi-Fi modem in mass production in the world.



Adjustable sensitivity

256 levels of sensitivity allow adjustment of the distance and the movement to which the sensor reacts.



Tamper detection

Tamper detection and 128 levels of vibration sensitivity will notify you about the slightest vibration.

CUSTOM ACTIONS

Create the perfect morning routine! Shelly Motion2 can trigger other smart devices in your home network and customize the actions based on your needs. The moment you wake up, Shelly Motion2 will trigger the automated blinds in your bedroom to open, allowing you to welcome the morning sunshine!

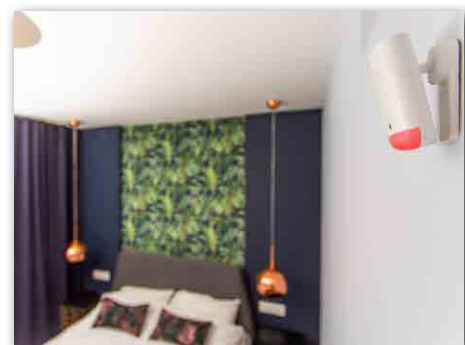

WI-FI MOTION SENSOR WITH OVER 1 YEAR OF BATTERY LIFE AND LIGHT & TEMPERATURE SENSORS

A new generation Motion Sensor powered by Silicon Labs Wi-Fi IoT solutions, **Shelly Motion2** is equipped with the lowest power-consuming Wi-Fi modem in mass production in the world and enhanced with a light and a temperature sensor for an even more efficient home automation.

TECHNICAL SPECIFICATIONS

Battery	6500 mAh 3.7 V
Battery life	12 - 36 months
Complies with EU standards:	<ul style="list-style-type: none">• RED 2014/53/EU• LVD 2014/35/EU• EMC 2014/30/EU• RoHS2 2011/65/EU
Working temperature	0°C to 40°C / 32°F to 105°F
Max RF power	20 dBm
Wireless/Wi-Fi Protocol	802.11 b/g/n (2.4 GHz)
Frequency	2401- 2495 MHz
Operational range (depending on local conditions)	<ul style="list-style-type: none">• Up to 30 m / 100 ft indoors• Up to 50 m / 160 ft outdoors
Dimensions (HxWxL)	<ul style="list-style-type: none">• 89.3x41.4x22.9 mm / 3.52x1.63x0.90 in (without stand)• 89.3x41.4x47.9 mm / 3.52x1.63x1.89 in (with stand)
Remote Control	Through mobile app & web interface
Compatibility	Android (4.2+) & iOS (8+), web browsers
Languages	Multiple through mobile app & web interface



ENERGY EFFICIENT LIGHTS

When you leave for work in the morning, Shelly Motion2 will ensure that all lights switch off once the house is empty and no motion is detected, ensuring that no energy will go to waste!

256 LEVELS OF SENSITIVITY

256 levels of sensitivity will allow you to adjust extremely precisely the distance and the movement to which the sensor reacts.

Easily adjust Shelly Motion2's sensitivity levels through the app wherever you are.



NO HUB REQUIRED

Shelly Motion2 can be controlled directly and without a hub through your smartphone. This way you can monitor and control your home, set scenes, and adjust settings wherever you are!



Shelly[®] H&T



MONITOR HUMIDITY IN YOUR HOME



MONITOR THE TEMPERATURE OF YOUR HEATER OR AIR CONDITIONER.



MONITOR THE TEMPERATURE IN YOUR FRIDGE OR COOLER



Humidity

Monitor excessive changes in humidity. Avoid dryness and conditions for mold growth.



Temperature

Be aware of temperature fluctuations and keep your home comfortable at any time.



Battery

Battery life up to 18 months. Feel more comfortable with the long-lasting battery life.

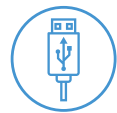

USB Add-on

You can power Shelly H&T with a USB instead of a battery using the USB power supply Add-on for Shelly H&T (sold separately, see in Accessories).



Easy control

The only thing you need to manage all your Shelly H&T devices is a mobile phone and the free Shelly Smart Control Application.



Wi-Fi

Connect Shelly H&T directly to your Wi-Fi.



Free history on Cloud

With Shelly H&T you can see recorded data for humidity and temperature for up to a year.

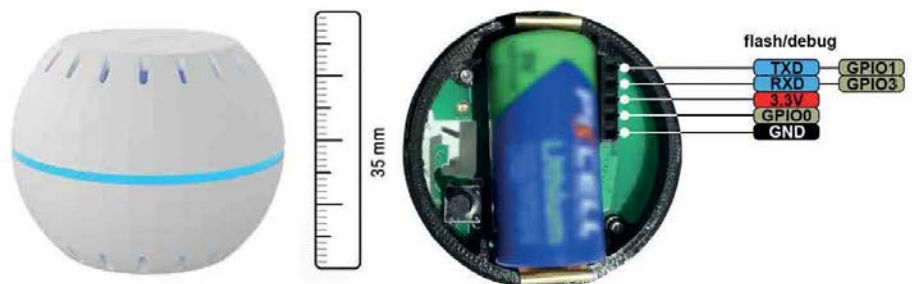

WI-FI HUMIDITY & TEMPERATURE SENSOR

Shelly H&T is the world's first Wi-Fi Humidity & Temperature sensor working over 1 year on battery

TECHNICAL SPECIFICATIONS

Battery	CR123A – 3 V (NOT included)
Battery life	Up to 18 months
Electrical consumption:	<ul style="list-style-type: none">• Static $\leq 70 \mu\text{A}$• Awake $\leq 250 \text{ mA}$
Humidity measurement range:	0~100% ($\pm 5\%$)
Measurement accuracy	$\pm 1^\circ\text{C}$
Working temperature	-10°C to 50°C
Max RF power	9,87 dBm
Wireless/Wi-Fi Protocol	802.11 b/g/n (2.4 GHz)
Frequency	2401- 2495 MHz
Operational range (depending on local conditions)	<ul style="list-style-type: none">• Up to 30 m / 100 ft indoors• Up to 50 m / 160 ft outdoors
Dimensions (HxWxL)	35x46x46 mm / 1.38x1.81x1.81 in
Complies with EU standards:	<ul style="list-style-type: none">• RED 2014/53/EU• LVD 2014/35/EU• EMC 2014/30/EU• RoHS2 2011/65/EU

- With Shelly H&T you can **optimize power consumption** for heating and cooling your home. Do not spend extra money on power consumption if you are not at home.
- **Humidity control** is very important for your health. Keep it at its optimal levels with Shelly H&T.
- Be informed **anytime, anywhere** about everything in your home and control it just with one app without any additional equipment.



Shelly TRV



2 YEARS BATTERY LIFE

Shelly TRV has 6500 mAh rechargeable battery with up to 2 years of battery life, based on 5 months heating season.



SMART PROFILES FOR ENHANCED ENERGY EFFICIENCY

Shelly TRV supports 5 profiles with 6 temperature points to each of them. You can set custom settings and control separately each profile to ensure efficient heating usage.

SMART SCHEDULING

Ensure the efficiency of your heating system by setting Shelly TRV to maintain different levels of heating according to the hour of the day. Customers can set lower levels of heating during working hours of the day.



Wi-Fi operated

Connect Shelly TRV to your Wi-Fi network. No HUB required



Long Battery Life

Up to 2 years of battery life, based on 5 months heating season.



Rechargeable battery

Shelly TRV is equipped with fully rechargeable battery.



Precise temperature measurement

Stay informed about the temperature of your radiators no matter where you are.



Wide range of temperature control

Set your room temperature in the range of 5°C to 30°C. (41°F to 86°F)



Quick Profiles

Set profiles and quickly switch between pre-defined settings and schedules.



Custom schedules and scenes

Set schedules and custom scenes based on your agenda and by combining Shelly TRV with other Shelly devices.

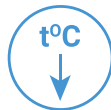

External temperature sensor support

Connect an external Wi-Fi sensor for precise temperature measurement.



Control your boiler or pump

Control your boiler/pump automatically to save energy.



No hub required

Control directly and without a hub through your smartphone with Shelly Smart Control App.



Highly compatible

Use with your preferred home automation platforms and voice assistants.

INTELLIGENT THERMOSTATIC RADIATOR VALVE FOR HIGHLY EFFICIENT HEATING MANAGEMENT

Shelly TRV replaces the old thermostatic valve in less than 5 minutes. It is enhanced with a rechargeable battery with 2 years of battery life. Shelly TRV supports 5 profiles with 6 temperature points to each of them and can activate custom scenes based on hour, light, or various actions.

TECHNICAL SPECIFICATIONS

Power supply	Built-in rechargeable battery. USB Type-C charging port (charger not included).
Battery life	Up to 2 years of battery life, based on 5 months heating season
Battery type	3.6 V, 6500 mAh, NCR18650BD Panasonic rechargeable battery
Power consumption	< 500 mA
Complies with EU standards:	<ul style="list-style-type: none"> • RED 2014/53/EU • LVD 2014/35/EU • EMC 2014/30/EU • RoHS2 2011/65/EU
Working temperature	0°C to 30°C / 32°F to 86°F
Temperature control range	5°C to 30°C / 41°F to 86°F
Max RF power	15 dBm
Wireless/Wi-Fi Protocol	802.11 b/g/n (2.4 GHz)
Frequency:	2401- 2495 MHz
Operational range (depending on local conditions)	<ul style="list-style-type: none"> • Up to 30 m / 100 ft indoors • Up to 50 m / 160 ft outdoors
Dimensions (HxWxL)	94x62x53 mm / 3.7x2.44x2.08 in

INSTALLATION IN 4 EASY STEPS

1) Remove your existing thermostatic valve of your radiator.



2) If needed, use one of adaptors included in the package.



3) Mount Shelly TRV on the radiator.



4) Connect Shelly TRV to your home Wi-Fi network and operate it through Shelly Smart Control Application.



Shelly[®] flood



INSTANT NOTIFICATIONS



DETECTS LEAKAGE

Place Shelly Flood anywhere you think there is a chance for leaks and get instant notification if water is detected.



USE YOUR FLOOR HEATING, ONLY WHEN YOU NEED IT

Shelly Flood informs you about the temperature fluctuations and help you set the right temperature for your floor heating.



Flood detection alarm

You will receive a notification if any fluid is detected by Shelly Flood.



Temperature

Be aware of temperature fluctuations and keep your floor heating at the desired temperature.



Battery

Feel comfortable with the up to 18 month battery life.



Easy control

The only thing you need to manage your Shelly Flood, is a mobile phone and the free Shelly Smart Control Application.



Wi-Fi

Connect Shelly Flood directly to your Wi-Fi.



Free history on Cloud

With Shelly Flood you can see recorded data for temperature up to a year.



FLOOD SENSOR WITH TEMPERATURE MEASUREMENT

With **Shelly Flood**, you can monitor the temperature of your home and receive instant notification if any liquid leakage is detected in your home

TECHNICAL SPECIFICATIONS

Battery	CR123A – 3V (NOT included)
Battery life	Up to 18 months
Electrical consumption	<ul style="list-style-type: none">• Static $\leq 5 \mu\text{A}$• Awake $\leq 100 \text{ mA}$• Alarm $\leq 120 \text{ mA}$
Measurement accuracy	$\pm 1^\circ\text{C} / \pm 1.8^\circ\text{F}$
Working temperature	-40°C to 60°C / -40°F to 140°F
Max RF power	10 dBm
Wireless/Wi-Fi Protocol	802.11 b/g/n (2.4 GHz)
Frequency	2401- 2495 MHz
Operational range (depending on local conditions)	<ul style="list-style-type: none">• up to 30 m / 100 ft outdoors• up to 10 m / 33 ft indoors
Dimensions (HxWxL)	70x70x19 mm / 2.75x2.75x0.74 in
Complies with EU standards	<ul style="list-style-type: none">• RED 2014/53/EU• LVD 2014/35/EU• EMC 2014/30/EU• RoHS2 2011/65/EU

EASY INSTALATION

3 easy steps

1. Download the Shelly Smart Control Application on your smartphone or tablet
2. Connect Shelly Flood sensor to your Wi-Fi router
3. Place the devise where there is even the slightest chance of leakage.



Shelly[®] Door/Window2



LIGHTING FAST RESPONSE

For at least 1.5 seconds the sensor will send local request to another Shelly device or over MQTT. Response time depends on the local Wi-Fi network. Signal strength, fixed IP address and fast router maintain fast association.



BATTERY LIFE

More than 12 000 wake-up and 18 months of battery life. The very low power CPU combined with 2x CR123A battery allow more than 2-year battery life thus making the Shelly Door/Window the device with longest battery life.



No additional controller

Shelly Door/Window sensor uses your home Wi-Fi network, no additional controllers are needed.



Open-close sensor

Shelly Door/Window detects and reports the opening and closing of doors and windows.



Temperature sensor

Be aware of temperature fluctuations and keep your home comfortable at any time.



Wire free

Simply place it at your door or window.



Free Cloud

All you need to manage your Shelly Door/Window sensor is a smartphone and the Shelly Cloud free mobile application.



Battery life up to 2 years

Feel more comfortable with the long-lasting battery life.

A DOOR AND WINDOW SENSOR WITH LUX MEASUREMENT AND FAST RESPONSE

Shelly Door/Window 2 is designed to detect and report the opening and closing of doors and windows. Its compact and improved design allows it to be easily installed on any door or window, and because of its lightweight, the sensor is nearly invisible.

TECHNICAL SPECIFICATIONS

Power Supply	Two 3 VDC - CR123A non-rechargeable
Battery Lifespan	up to 18 months
Complies with EU standards	<ul style="list-style-type: none">• RED 2014/53/EU• LVD 2014/35/EU• EMC 2014/30/EU• RoHS2 2011/65/EU
Working temperature	-10 to 50°C
Max RF power	12.71 dBm
Radio protocol	Wi-Fi 802.11 b/g/n
Frequency	2401- 2495 MHz
Operational range (depending on local conditions)	<ul style="list-style-type: none">• Up to 30 m / 100 ft indoors• Up to 50 m / 160 ft outdoors
Dimensions	Sensor 82x23x20mm / 3.22x0.90x0.78 in Magnet 52x16x13mm / 2.04x0.62x0.51
Electrical consumption	Static current: ≤10 μA Alarm current: ≤60 mA

Easy set up:

1. Attach Shelly Door/Window2 sensor to any door or window frame. The two parts of the sensor need to be close to one another.
2. Download the Shelly Smart Control Application on your smartphone or tablet.
3. Connect Shelly Door/Window2 to your Wi-Fi router
4. Add Shelly Door/Window2 to Shelly Cloud.



Door/window is opened



230LUX is detected



Light ON

via REST HTTP/MQTT/CoAP/Cloud

Shelly[®] GAS



LPG AND CNG VERSION

Shelly Gas comes in two versions - with LPG (Liquefied Petroleum Gas) or CNG (Compressed Natural Gas) detection. Shelly GAS supports interchangeable plug extensions in order to be compatible with different power socket standards.



INTERCHANGEABLE PLUG

Shelly GAS supports interchangeable plug extensions in order to be compatible with different power socket standards.



PROTECT YOUR HOME

Thanks to its high sensitivity, Shelly Gas will immediately detect gas leakage and release light and sound alarms, as well as will send notification to your phone in case you are away of home.



No additional controller

Shelly GAS sensor uses your home Wi-Fi network, no additional controllers are needed.



Gas sensor

A smart gas sensor that can detect LPG or CNG and monitor your household's safety.



Flame resistant

With a flame resistant shell, Shelly GAS will be always there for you.



Wire free

Simply plug it to your power socket.



Free Cloud

All you need to manage your Shelly GAS sensor is a smartphone and the Shelly Cloud free mobile application.



GAS concentration

Low: 1800 ppm; High: 3000 ppm

SMART WI-FI GAS DETECTOR FOR LPG OR CNG

Many home appliances are dependent on natural gas, but not many homes have sensory detection for gas leaks, which can be dangerous. Shelly GAS can detect Natural Gas or Liquefied petroleum gas helping you provide additional protection for your home and family. Its long life span, little sensitivity drift, and Wi-Fi technology allow you always to know if gas is threatening your home.

TECHNICAL SPECIFICATIONS

Power Supply	110-230 VAC \pm 10%, 50/60Hz
Alarm indicator	LED Flash & Sound
Alarm sensitivity	6% LEL
Valve manipulator jack output	11-13 V, 500 mA
Sound level	\geq 70 dB
Gas detector	LPG or CNG
Complies with EU standards	<ul style="list-style-type: none">• RED 2014/53/EU• LVD 2014/35/EU• EMC 2014/30/EU• RoHS2 2011/65/EU
Working temperature	-10°C to 50°C / 14°F to 122°F
Max RF power	16.28 dBm
Radio protocol	Wi-Fi 802.11 b/g/n
Frequency	2401- 2495 MHz
Operational range (depending on local conditions)	<ul style="list-style-type: none">• Up to 30 m / 100 ft indoors• Up to 50 m / 160 ft outdoors
Dimensions	89,5x89,5x38 mm / 3.52x3.52x1.49 in (plug not included)
Electrical consumption	< 3 W

SMART SCENES

Shelly GAS can be placed almost anywhere - in the kitchen, in your bathroom, etc. Just put the device anywhere you think there is even a slight chance for gas leakage, and create your scenes for when gas is detected - windows can be opened, doors unlocked, or lights turned on.



Shelly[®] DUO



COLOR TEMPERATURE GUIDE

2700K



3500K



4500K



6000K

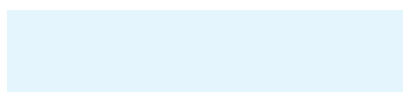

6500K

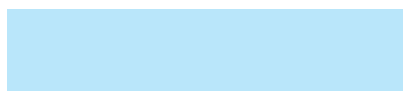

Wi-Fi Connected

No HUB required – Connect Shelly Bulb directly to your Wi-Fi at home and dim it.



Energy Efficient

Reduce energy usage without brightness or quality loss.



Easy Control

The only thing you need to manage all your Shelly Bulbs is a mobile phone and the free Shelly Smart Control Application.



Dimmable light

Enjoy dimmable light by fine-tuning your brightness.



Set Schedules

Shelly Bulb can wake you up and help you energize, read, concentrate and relax.



Highly Compatible

Compatible with Android, iOS, Amazon Alexa and Google Assistant.



Follow the Sunlight

Shelly Bulb can automatically turn on/off based on the sunrise and sunset hours.

SMART DIMMABLE BULB

Shelly Duo - Wi-Fi on board, Cloud and MQTT enabled, dimmable, voice control, smart Wake-up and Night mode. Automatically follow the sun and control your light accordingly. You can set your Shelly Duo bulbs directly from your phone and have them turn on/off based on the sunrise and sunset hours. Set Wake-up or Night mode with soft, dimmed light and the right color temperature.

TECHNICAL SPECIFICATIONS

	Shelly DUO	Shelly DUO GU10
Power supply	210-230 VAC, 50/60 Hz	
Socket	E27	GU10
Power Rating	9 W	5 W
Brightness	Warm White: 475 lm	Warm White: 475 lm
Color Temperature	2700 K - 6500 K	2700 K - 6500 K
Working temperature	-10°C to +40°C / 14°F to + 105°F	-10°C to +40°C / 14°F to + 105°F
Beam Angle	180°	120°
Complies with EU standards	<ul style="list-style-type: none"> • RED 2014/53/EU • LVD 2014/35/EU • EMC 2014/30/EU • RoHS2 2011/65/EU 	
Max RF power	15 dBm	
Radio protocol	Wi-Fi 802.11 b/g/n	
Frequency	2401- 2495 MHz	
Operational range (depending on local construction)	<ul style="list-style-type: none"> • up to 15 m /49 ft outdoors • up to 8 m / 26 ft indoors 	
Dimensions	60x122 mm / 2.36x4.08 in	50x73 mm / 1.96x2.87 in
Electrical consumption	< 1 W	



Shelly DUO RGBW



16 MILLION COLORS

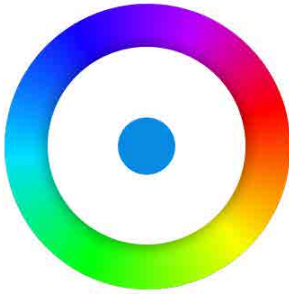

Wi-Fi operated

Connect Shelly Bulb to your Wi-Fi at home.



Energy efficient

Reduce energy usage without brightness or quality loss.



16 million colors

Set the mood by choosing between 16 million colors.



Light temperature control

Easily set the desired light temperature.



Control remotely

Turn Shelly Bulb RGBW ON/OFF directly from your smartphone or tablet, and manage them easily no matter where you are.



Weekly Schedules

Easily create custom daily schedules and smart timers.



Sunrise/Sunset

Set Shelly Bulb RGBW to automatically turn ON/OFF based on sunrise and sunset hours.



No hub required

Control directly and without a hub through your smartphone with Shelly Smart Control App.



Highly compatible

Use with your preferred home automation platforms and voice assistants.

WARM AND COLD LIGHT



SMART RGBW BULB WITH 16 MILLION COLORS

Shelly Bulb RGBW allows customers to control and adjust the brightness and the color of their light, choosing between 16 million colors. Shelly Bulb RGBW connects directly to the Wi-Fi at home and allows setting custom schedules, smart scenarios and Sunrise/Sunset actions.

TECHNICAL SPECIFICATIONS

	Shelly DUO	Shelly DUO GU10
Power supply	110-230 VAC ±10%, 50/60 Hz	
Socket	E27	GU10
Power Rating	9 W	5 W
Brightness	Warm White: 475 lm	Warm White: 475 lm
Color Temperature	3000 K - 6500 K	3000 K - 6500 K
Working temperature	-10°C to 40°C / 14°F to 105°F	
Beam Angle	180°	120°
Complies with EU standards	<ul style="list-style-type: none"> • RED 2014/53/EU • LVD 2014/35/EU • EMC 2014/30/EU • RoHS2 2011/65/EU 	
Max RF power	15 dBm	
Radio protocol	Wi-Fi 802.11 b/g/n	
Frequency	2401- 2495 MHz	
Operational range (depending on local construction)	<ul style="list-style-type: none"> • up to 15 m / 49 ft outdoors • up to 8 m / 26 ft indoors 	
Dimensions	60x122 mm / 2.36x4.08 in	50x73 mm / 1.96x2.87 in
Electrical consumption	< 1 W	



Shelly® Vintage



A60 MODEL



ST64 MODEL

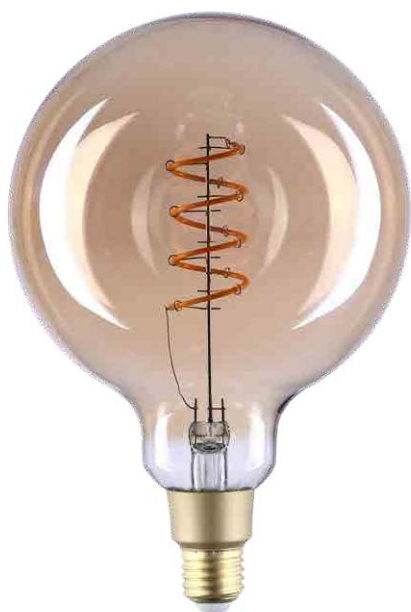

G125 MODEL



Wi-Fi Connected

No HUB required – Connect Shelly Bulb directly to your Wi-Fi at home and choice of 16 million colors.



Energy Efficient

Reduce energy usage without brightness or quality loss.



Easy Control

The only thing you need to manage all your Shelly Bulbs is a mobile phone and the free Shelly Smart Control Application.



Dimmable light

Enjoy dimmable light by fine-tuning your brightness.



Set Schedules

Shelly Bulb can wake you up and help you energize, read, concentrate and relax.



Highly Compatible

Compatible with Android, iOS, Amazon Alexa and Google Assistant.



Follow the Sunlight

Shelly Bulb can automatically turn on/off based on the sunrise and sunset hours.

SMART DIMMABLE VINTAGE BULB

Shelly Vintage - Wi-Fi on board, Cloud and MQTT enabled, dimmable, voice control, smart Wake-up and Night mode. The smart vintage bulbs with spectacular design! Automatically follow the sun and set your light accordingly. You can control your Shelly Vintage bulbs directly from your phone and have them turn on/off based on the sunrise and sunset hours. Set Wake-up or Night mode with soft, dimmed light.

TECHNICAL SPECIFICATIONS

Type	A60	ST64	G126
Power supply	7 W		4 W
Socket	E27		
Power Rating	PF > 0.5		
Brightness	750 lm	260 lm	
Color Temperature	2700 K		
Working temperature	-10°C to +40°C / 14°F to + 105°F		
Beam Angle	360°		
Complies with EU standards	<ul style="list-style-type: none"> • RED 2014/53/EU • LVD 2014/35/EU • EMC 2014/30/EU • RoHS2 2011/65/EU 		
Max RF power	15 dBm		
Radio protocol	Wi-Fi 802.11 b/g/n		
Frequency	2401- 2495 MHz		
Operational range (depending on local construction)	up to 15 m / 49 ft outdoors up to 8 m / 26 ft indoors		
Dimensions	60x115 mm / 2.36x4.52 in	64x160 mm / 2.51x6.29 in	125x155 mm / 4.92x6.10 in
Electrical consumption	< 1 W		

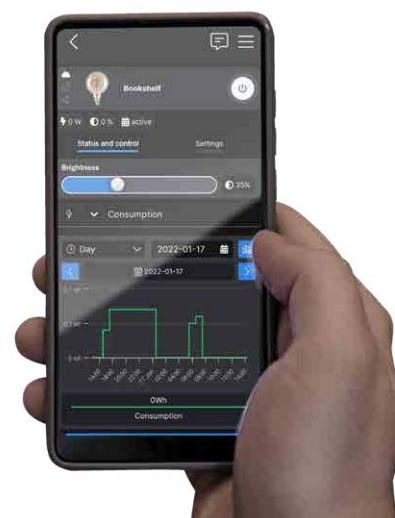

QUICK AND EASY SET UP:

1. Screw in your Shelly Vintage Bulb in the light socket.
2. Download the Shelly Smart Control Application on your smartphone or tablet.
3. Connect Shelly Vintage bulb to your Wi-Fi router
4. Add Shelly Vintage bulb to Shelly Cloud and browse through the many possible settings.



ACCESSORIES FOR SHELLY PRODUCTS

With these accessories you can improve your experience with Shelly products.

Shelly Button

Safe way to use Shelly 1, Shelly 1PM and Shelly Dimmer out of the wall. You can make any table light, fan or heater smart.



Shelly H&T power adapter

You can power your Shelly H&T with USB instead of battery.



Outdoor IP55 AddOn - UK

Split core current transformer

Used together with Shelly EM or Shelly 3EM for energy metering.

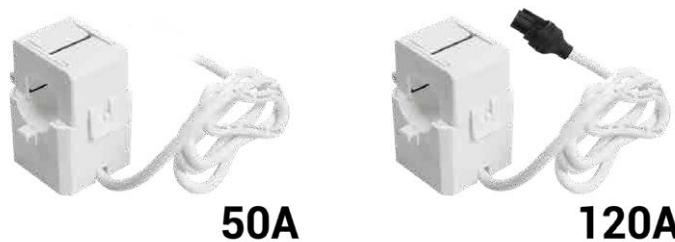

Shelly GAS addon manipulator

Shelly Plus Add-On

Add-on for Shelly Plus devices. Can be used with up to five DS18B20 sensors or one DHT22 sensor.



Bypass

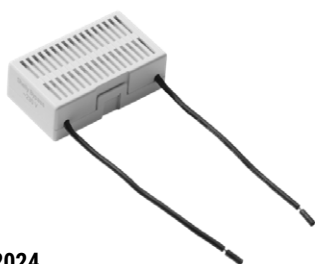

WALL SWITCH FOR SMART DEVICE

Designed to facilitate your specific automation needs and developed with the smallest details in mind, you can now create a custom wall switch for your Shelly device, and save on space and money!

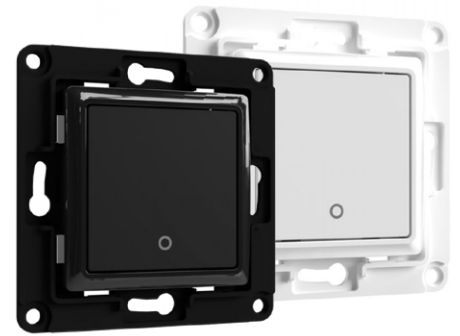

FITS INTO THE TINIEST SPACES!

Compact dimensions and simple wiring that can fit into any existing switch console or even the tiniest spaces.

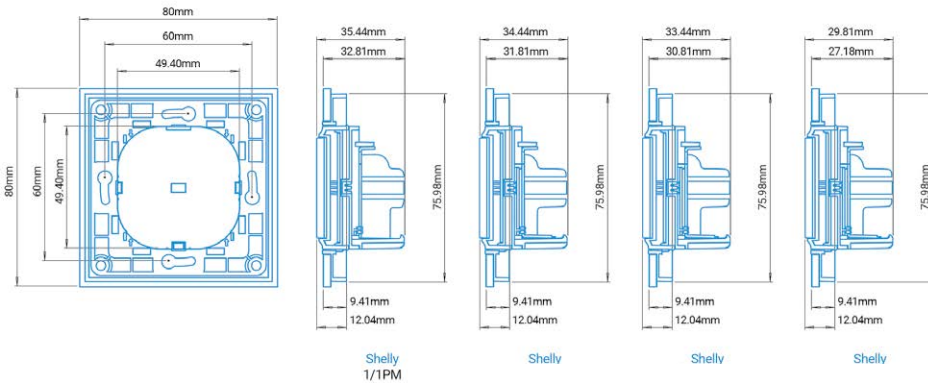

HIGHLY CUSTOMIZABLE!

Each Shelly Wall Switch for Smart device comes with corresponding holders. You can choose the device holder that you need to fulfill your automation project.

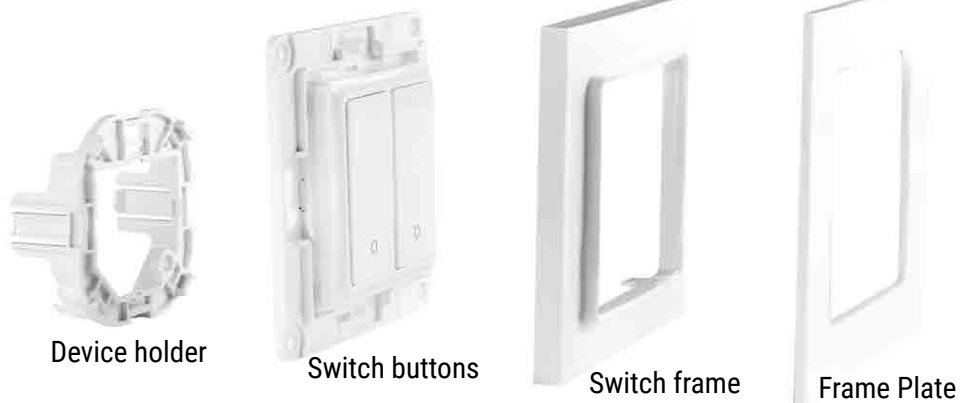

AVAILABLE SWITCHES*:

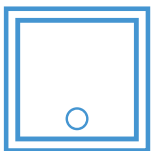

Plus series
1/1PM
1L/Dimmer2

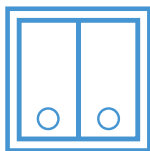

Plus series
2.5
1L/Dimmer2

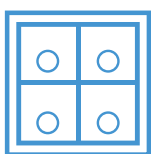

Plus i4

AVAILABLE FRAMES*:

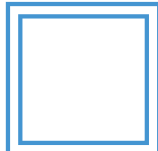

Single
frame

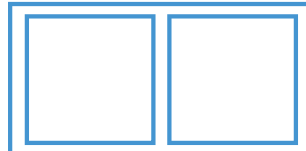

Double
frame

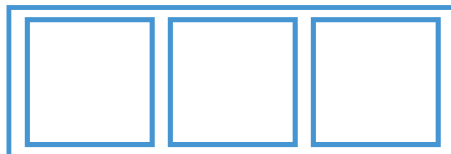

Triple frame

AVAILABLE COLORS:



White



Black

*Shelly Wall switches and Shelly Wall frames are sold separately!

